

Digital Video Camera Recorder

Operating Instructions

Before operating the unit, please read this manual thoroughly, and retain it for future reference.

Owner's Record

The model and serial numbers are located on the bottom. Record the serial number in the space provided below. Refer to these numbers whenever you call upon your Sony dealer regarding this product.

Model No. **DCR-TRV** _____ Model No. **AC**- _____

Serial No. _____ Serial No. _____

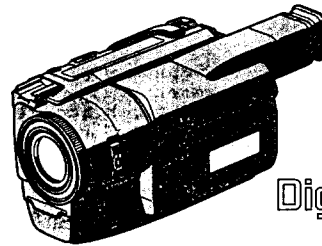

Digital Handycam

Digital 8

InfoLITHIUM

DCR-TRV103/TRV110

Welcome!

Congratulations on your purchase of this Sony Digital Handycam camcorder. With your Digital Handycam, you can capture life's precious moments with superior picture and sound quality. Your Digital Handycam is loaded with advanced features, but at the same time it is very easy to use. You will soon be producing home video that you can enjoy for years to come.

WARNING

To prevent fire or shock hazard, do not expose the unit to rain or moisture.

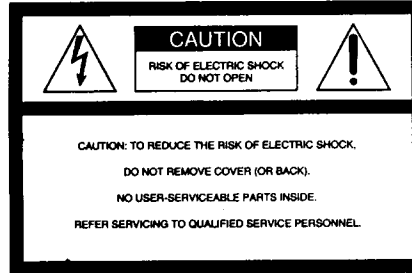

This symbol is intended to alert the user to the presence of uninsulated "dangerous voltage" within the product's enclosure that may be of sufficient magnitude to constitute a risk of electric shock to persons.



This symbol is intended to alert the user to the presence of important operating and maintenance (servicing) instructions in the literature accompanying the appliance.

Never expose the battery pack to temperatures above 140°F (60°C) such as in a car parked in the sun or under direct sunlight.

DISPOSAL OF LITHIUM ION BATTERY. LITHIUM ION BATTERY. DISPOSE OF PROPERLY.

You can return your unwanted lithium ion batteries to your nearest Sony Service Center or Factory Service Center.

Note: In some areas the disposal of lithium ion batteries in household or business trash may be prohibited.

For the Sony Service Center nearest you call 1-800-222-SONY (United States only)

For the Sony Factory Service Center nearest you call 416-499-SONY (Canada only)

Caution: Do not handle damaged or leaking lithium ion battery.

For customers in the U.S.A.

CAUTION

You are cautioned that any changes or modifications not expressly approved in this manual could void your authority to operate this equipment.

Declaration of Conformity

Trade Name: SONY
Model No.: DCR-TRV103,
DCR-TRV110
Responsible Party: Sony Electronics Inc.
Address: 1 Sony Drive, Park Ridge,
NJ, 07656 USA
Telephone No.: 201-930-6970

This device complies with Part 15 of the FCC Rules. Operation is subject to the following two conditions: (1) This device may not cause harmful interference, and (2) this device must accept any interference received, including interference that may cause undesired operation.

Note:

This equipment has been tested and found to comply with the limits for a Class B digital device, pursuant to Part 15 of the FCC Rules. These limits are designed to provide reasonable protection against harmful interference in a residential installation. This equipment generates, uses, and can radiate radio frequency energy and, if not installed and used in accordance with the instructions, may cause harmful interference to radio communications. However, there is no guarantee that interference will not occur in a particular installation. If this equipment does cause harmful interference to radio or television reception, which can be determined by turning the equipment off and on, the user is encouraged to try to correct the interference by one or more of the following measures:

- Reorient or relocate the receiving antenna.
- Increase the separation between the equipment and receiver.
- Connect the equipment into an outlet on a circuit different from that to which the receiver is connected.
- Consult the dealer or an experienced radio/TV technician for help.

For customers in CANADA

CAUTION

TO PREVENT ELECTRIC SHOCK, MATCH WIDE BLADE OF PLUG TO WIDE SLOT, FULLY INSERT.

Table of contents

Quick Start Guide 4

Getting started

Using this manual	6
Checking supplied accessories	7
Step 1 Preparing the power supply	8
Installing the battery pack	8
Charging the battery pack	9
Connecting to a wall outlet	11
Step 2 Inserting a cassette	12

Recording – Basics

Reordering a picture	13
Shooting backlit subjects (BACK LIGHT)	18
Shooting in the dark (NightShot)	18
Checking the recording – END SEARCH / EDITSEARCH / Rec Review	20

Playback – Basics

Playing back a tape	21
Viewing the recording on TV	24

Advanced Recording Operations

Photo recording	26
Using the wide mode	28
Using the fader function	29
Using special effects – Picture effect	32
Using special effects – Digital effect	33
Using the PROGRAM AE function	36
Adjusting the exposure manually	38
Focusing manually	39
Inserting a scene	40

Advanced Playback Operations

Playing back a tape with picture effects	41
Playing back a tape with digital effects	42
Quickly locating a scene using the zero set memory function	43
Searching a recording by date	44
Searching for a photo – Photo search/Photo scan	46

Editing on Other Equipment

Dubbing a tape	48
Recording video or TV programs	50
Inserting a scene from a VCR	51

Customizing Your Camcorder

Changing the MENU settings	53
Resetting the date and time	58

Additional Information

Digital8  system, recording and playback	59
Changing the lithium battery in your camcorder	61
Troubleshooting	63
Self-diagnosis display	67
Warning indicators and messages	68
Using your camcorder abroad	69
Maintenance information and precautions	70
Specifications	74

Quick Reference

Identifying the parts and controls	75
Quick Function Guide	82
Index	83

Quick Start Guide



This chapter introduces you to the basic features of your camcorder. See the page in parentheses "()" for more information.

1 Connecting the power cord (p. 11)

Use the battery pack when using your camcorder outdoors (p. 8).

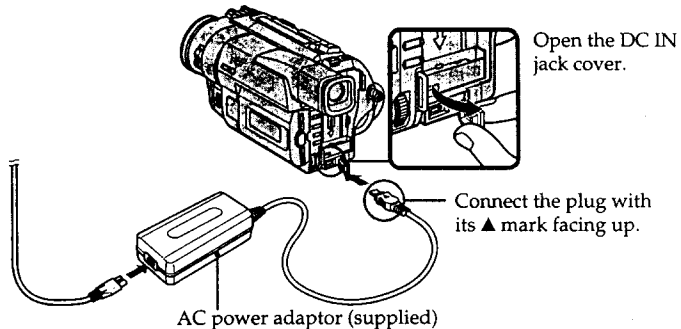

2 Inserting a cassette (p. 12)

1 Slide EJECT in the direction of the arrow while pressing the small blue button.

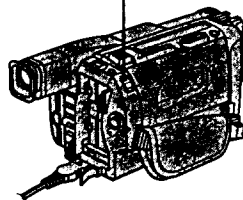

2 Insert a cassette into the cassette compartment with its window facing out.

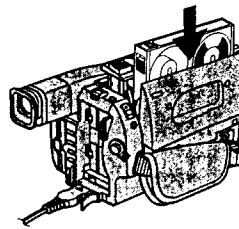

3 Close the cassette compartment by pressing the "PUSH" mark on the cassette compartment. The cassette compartment automatically goes down.

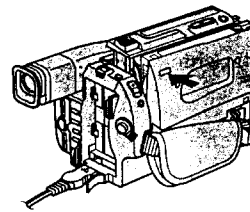

3 Recording a picture (p. 13)

1 Remove the lens cap.

2 Set the POWER switch to CAMERA while pressing the small green button.

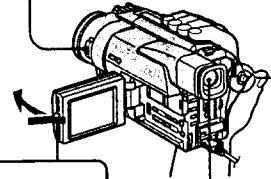

3 Open the LCD panel while pressing OPEN.

Viewfinder
When the LCD panel is closed, use the viewfinder placing your eye against its eyecup.

4 Turn STANDBY to STANDBY. The picture appears on the LCD screen.

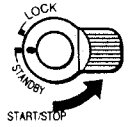

5 Press the red button. Your camcorder starts recording. To stop recording, press the red button again.



4 Monitoring the playback picture on the LCD screen (p. 21)

1 Set the POWER switch to VTR while pressing the small green button.

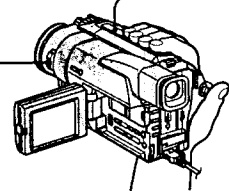
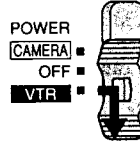

2 Press ◀◀ to rewind the tape.



3 Press ▶▶ to start playback.



NOTE
Do not pick up your camcorder by holding the viewfinder or by holding the LCD panel.

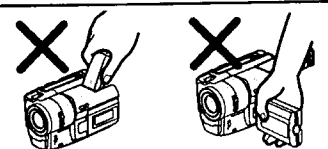

Using this manual

As you read through this manual, buttons and settings on your camcorder are shown in capital letters.

e.g. Set the POWER switch to CAMERA.

When you carry out an operation, you can hear a beep sound to indicate that the operation is being carried out.

Before using your camcorder

With your digital camcorder, you can use Hi8 video cassettes **Hi8**.

Your camcorder records and plays back pictures in the Digital8 **D8** system. Also, your camcorder plays back tapes recorded in the Hi8 **Hi8**/standard 8 **8** (analog) system.

You, however, cannot use the functions in "Advanced Playback Operations" on page 41 to 47 for playback in the Hi8 **Hi8**/standard 8 **8** system. To enable smooth transition, we recommend that you do not mix pictures recorded in the Hi8 **Hi8**/standard 8 **8** with the Digital8 **D8** system on a tape.

Note on TV color systems

TV color systems differ from country to country. To view your recordings on a TV, you need an NTSC system-based TV.

Copyright precautions

Television programs, films, video tapes, and other materials may be copyrighted. Unauthorized recording of such materials may be contrary to the provision of the copyright laws.

Precautions on camcorder care

- The LCD screen is manufactured using high-precision technology. However, there may be some tiny black spots and/or bright spots (red, blue or green in color) that constantly appear on the LCD screen. These spots occur normally in the manufacturing process and do not affect the recorded picture in any way. Effective number of pixels is 99.99% or more.
- Do not let your camcorder get wet. Keep your camcorder away from rain and sea water. Letting your camcorder get wet may cause your camcorder to malfunction. Sometimes this malfunction cannot be repaired **[a]**.
- Never leave your camcorder exposed to temperatures above 140°F (60°C), such as in a car parked in the sun or under direct sunlight **[b]**.
- Do not place your camcorder so as to point the viewfinder or the LCD screen toward the sun. The inside of the viewfinder or LCD screen may be damaged **[c]**.

[a]

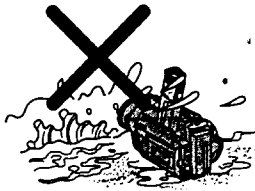

[b]

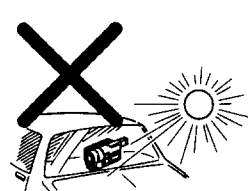

[c]

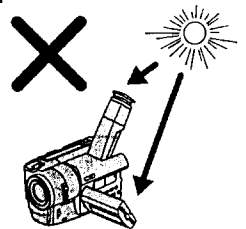

Checking supplied accessories

Make sure that the following accessories are supplied with your camcorder.

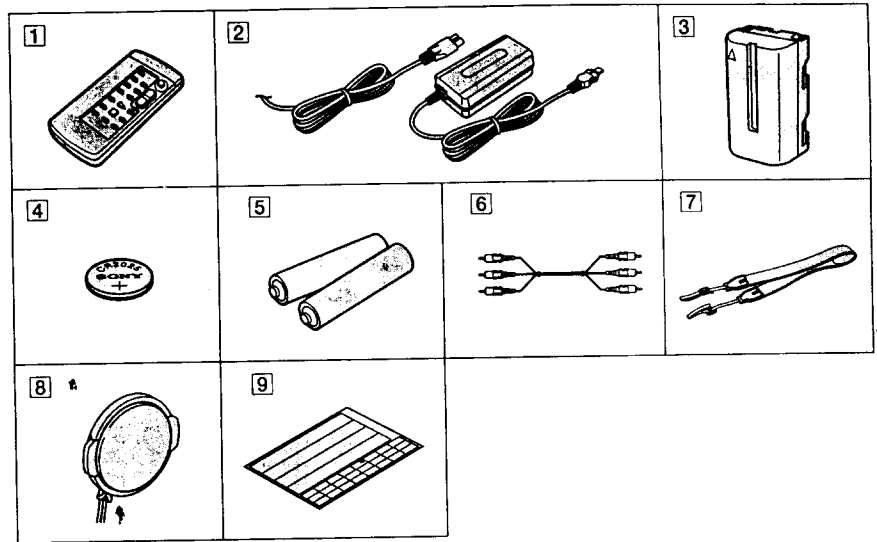

Getting started

1 Wireless Remote Commander (1)
(p. 80)

2 AC-L10A/L10B/L10C AC power adaptor
(1), Power cord (1) (p. 9)

3 NP-F330 battery pack (1) (p. 8, 9)

4 CR2025 lithium battery (1) (p. 61)
The lithium battery is already installed
in your camcorder.

5 Size AA (R6) battery for Remote
Commander (2) (p. 80)

6 A/V connecting cable (1) (p. 24)

7 Shoulder strap (1) (p. 77)

8 Lens cap (1) (p. 13)

9 Label sheet for cassette (1)
Stick this label on the recorded cassette.

Contents of the recording cannot be compensated if recording or playback is not made due to a malfunction of the camcorder, video tape, etc.

Step 1 Preparing the power supply

Installing the battery pack

Install the battery pack to use your camcorder outdoors.

Slide the battery pack down.

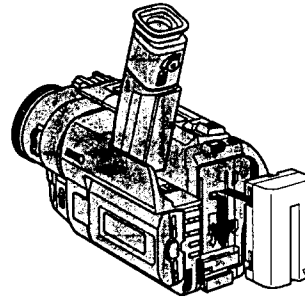

To remove the battery pack

Slide the battery pack out in the direction of the arrow while pressing ↓ BATT RELEASE down.

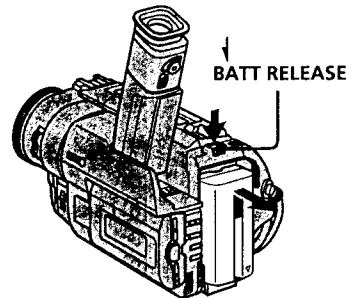

After installing the battery pack

Do not carry your camcorder by holding the battery pack. If you do so, the battery pack may slide off your camcorder unintentionally, damaging your camcorder.

Step 1 Preparing the power supply

Charging the battery pack

Use the battery pack after charging it for your camcorder.
Your camcorder operates only with the "InfoLITHIUM" battery pack (L series).

"InfoLITHIUM" is a trademark of Sony Corporation.

- (1) Open the DC IN jack cover and connect the AC power adaptor supplied with your camcorder to the DC IN jack with the plug's ▲ mark facing up.
- (2) Connect the power cord to the AC power adaptor.
- (3) Connect the power cord to a wall outlet.
- (4) Set the POWER switch to OFF. Charging begins. The remaining battery time is indicated in minutes on the display window.

When the remaining battery indicator changes to , **normal charge** is completed. To fully charge the battery (**full charge**), leave the battery pack attached for about 1 hour after normal charge is completed until FULL appears in the display window. Fully charging the battery allows you to use the battery longer than usual.

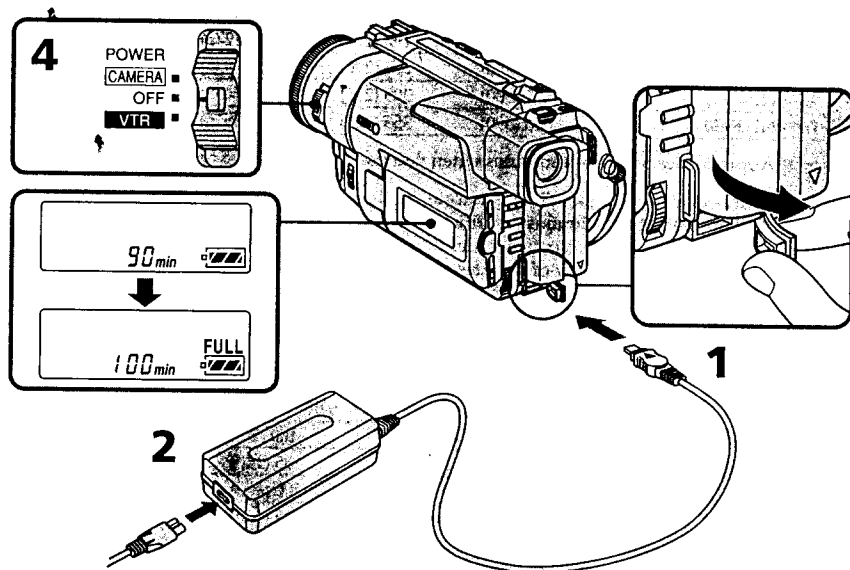

Note

Prevent metallic objects from coming into contact with the metal parts of the DC plug of the AC power adaptor. This may cause a short-circuit, damaging the AC power adaptor.

Remaining battery time indicator

The remaining battery time indicator in the display window roughly indicates the recording time with the viewfinder.

Battery pack

The battery pack is charged a little before it leaves the factory.

Until your camcorder calculates the actual remaining battery time

"---- min" appears in the display window.

Step 1 Preparing the power supply

Charging time

Battery pack	Full charge (Normal charge)
NP-F330 (supplied)	150 (90)
NP-F530/F550	210 (150)
NP-F730/F730H/F750	300 (240)
NP-F930/F950	390 (330)

Approximate number of minutes to charge an empty battery pack

Recording time

Battery pack	Recording with the viewfinder		Recording with the LCD screen	
	Continuous*	Typical**	Continuous*	Typical**
NP-F330 (supplied)	100 (90)	55 (50)	90 (80)	50 (40)
NP-F530	170 (155)	95 (85)	150 (135)	85 (75)
NP-F550	205 (185)	110 (100)	185 (165)	100 (90)
NP-F730	350 (310)	195 (170)	305 (275)	170 (150)
NP-F730H/F750	425 (380)	235 (210)	375 (335)	205 (185)
NP-F930	555 (500)	305 (275)	480 (435)	265 (240)
NP-F950	650 (590)	355 (325)	570 (515)	310 (285)

Approximate number of minutes when you use a fully charged battery

Numbers in parentheses "()" indicate the time using a normally charged battery.

* Approximate continuous recording time at 77°F (25°C). The battery life will be shorter if you use your camcorder in a cold environment.

** Approximate number of minutes when recording while you repeat recording start/stop, zooming and turning the power on/off. The actual battery life may be shorter.

Playing time

Battery pack	Playing time on LCD screen	Playing time with LCD closed
NP-F330 (supplied)	90 (80)	100 (90)
NP-F530	145 (130)	165 (150)
NP-F550	175 (160)	200 (180)
NP-F730	300 (270)	335 (300)
NP-F730H/F750	365 (325)	410 (365)
NP-F930	475 (430)	535 (480)
NP-F950	555 (500)	630 (570)

Approximate number of minutes when you use a fully charged battery

Numbers in parentheses "()" indicate the time using a normally charged battery. The battery life will be shorter if you use your camcorder in a cold environment.

Step 1 Preparing the power supply

After charging the battery pack

Disconnect the AC power adaptor from the DC IN jack on your camcorder.

Note on the remaining battery time indicator during recording

The indicator may not be correct, depending on the conditions in which you are recording. When you close the LCD panel and open it again, it takes about 1 minute for the correct remaining battery time to be displayed.

What is "InfoLITHIUM"?

The "InfoLITHIUM" is a lithium ion battery pack which can exchange data such as battery consumption with compatible video equipment. This unit is compatible with the "InfoLITHIUM" battery pack (L series). Your camcorder operates only with the "InfoLITHIUM" battery. "InfoLITHIUM" battery packs have the  InfoLITHIUM mark. "InfoLITHIUM" is a trademark of Sony Corporation.

Connecting to a wall outlet

- When you use your camcorder for a long time, we recommend that you power it from a wall outlet using the AC power adaptor.

- (1) Open the DC IN jack cover, and connect the AC power adaptor to the DC IN jack on your camcorder with the plug's ▲ mark facing up.
- (2) Connect the power cord to the AC power adaptor.
- (3) Connect the power cord to a wall outlet.

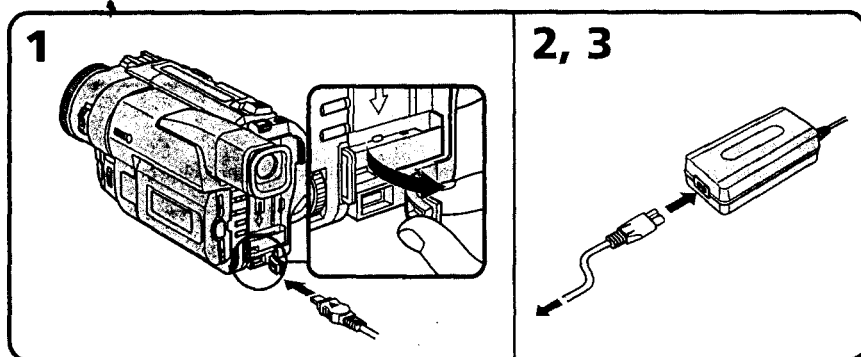

WARNING

The power cord must only be changed at a qualified service shop.

PRECAUTION

The set is not disconnected from the AC power source (house current) as long as it is connected to the wall outlet, even if the set itself has been turned off.

Notes

- The AC power adaptor can supply power even if the battery pack is attached to your camcorder.
- The DC IN jack has "source priority". This means that the battery pack cannot supply any power if the power cord is connected to the DC IN jack, even when the power cord is not plugged into a wall outlet.
- Keep the AC power adaptor away from the camcorder if the picture is disturbed.

Using a car battery

Use Sony DC Adaptor/Charger (not supplied).

Step 2 Inserting a cassette

We recommend using Hi8 video cassette **Hi8**.

If you use standard 8 tape, be sure to play back the tape on this camcorder. Your camcorder records in the Digital8 system.

- (1) Slide EJECT in the direction of the arrow while pressing the small blue button. The cassette compartment automatically lifts up and opens.
- (2) Insert a cassette with its window facing out and the tab on the cassette up.
- (3) Close the cassette compartment by pressing the "PUSH" mark on the cassette compartment. The cassette compartment automatically goes down.

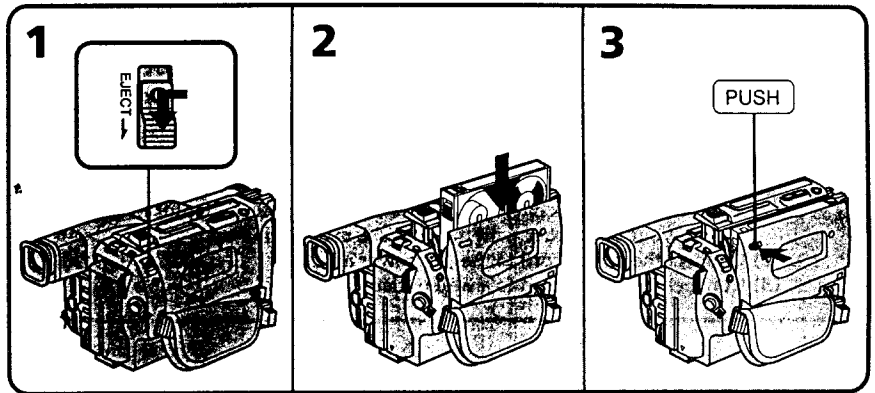

To eject a cassette

Slide EJECT in the direction of the arrow while pressing the small blue button.

Notes

- The recording time when you use your Digital8 system camcorder on Hi8/standard 8 tape is half the recording time when using the conventional Hi8/standard 8 system camcorder.
- If you use standard 8 tape, be sure to play back the tape on this camcorder. Mosaic pattern noise may appear when you play back standard 8 tape on other VCRs.
- Do not press the cassette compartment down. Doing so may cause malfunction.

To prevent accidental erasure

Slide the write-protect tab on the cassette to expose the red mark.



Recording a picture

Your camcorder automatically focuses for you.

- (1) Remove the lens cap by pressing both knobs on its sides and attach the lens cap to the grip strap.
- (2) Install the power source and insert a cassette. See "Step 1" and "Step 2" for more information (p. 8 to 12).
- (3) Set the POWER switch to CAMERA while pressing the small green button.
- (4) Open the LCD panel while pressing OPEN. The viewfinder automatically turns off.
- (5) Turn STANDBY to STANDBY.
- (6) Press START/STOP. Your camcorder starts recording. The "REC" indicator appears. The camera recording lamp located on the front of your camcorder lights up. To stop recording, press START/STOP again. The recording lamp lights up in the viewfinder when you record with the viewfinder.

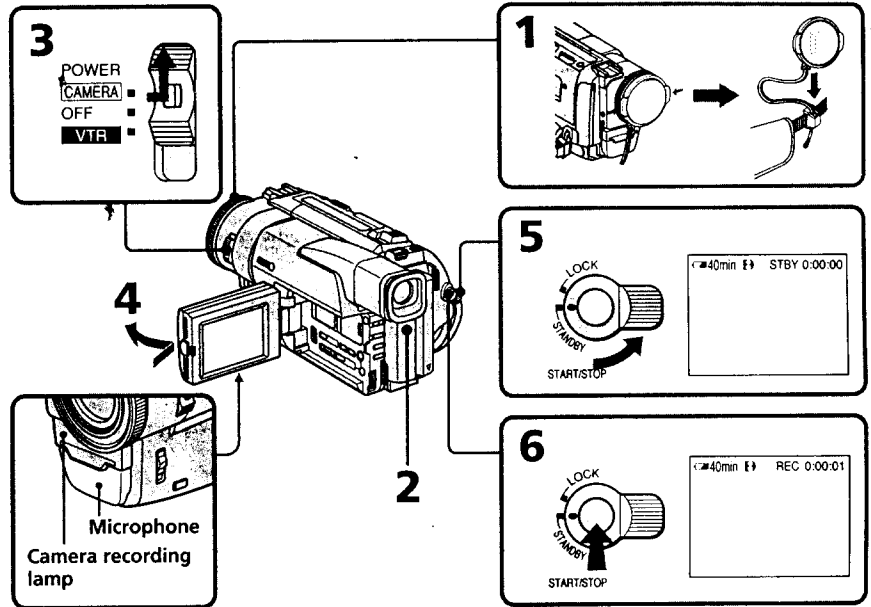

Note

Fasten the grip strap firmly. Do not touch the built-in microphone during recording.

To enable smooth transition

You can make the transition between the last scene you recorded and the next scene smooth as long as you do not eject the cassette. When you exchange the battery pack in the recording mode, set STANDBY to LOCK.

If you leave your camcorder in the standby mode for 3 minutes while the cassette is inserted

Your camcorder automatically turns off. This is to save battery power and to prevent battery and tape wear. To resume the standby mode, turn STANDBY down and up again. To start recording, press START/STOP.

Recording a picture

Adjusting the LCD screen

To adjust the brightness of the LCD screen, press either of the two buttons on LCD BRIGHT.

The LCD panel moves about 90 degrees to the viewfinder side and about 210 degrees to the lens side.

If you turn the LCD panel over so that it faces the other way, the ☺ indicator appears in the viewfinder and on the LCD screen (**Mirror mode**).

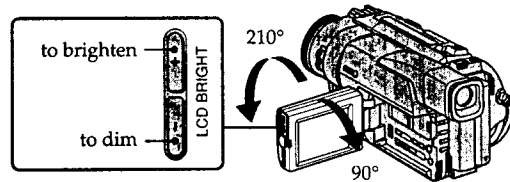

When closing the LCD panel, set it vertically until it clicks, and swing it into the camcorder body.

Note

When using the LCD screen except in the mirror mode, the viewfinder automatically turns off.

When you use the LCD screen outdoors in direct sunlight

The LCD screen may be difficult to see. If this happens, we recommend that you use the viewfinder.

Picture in the mirror mode

The picture on the LCD is a mirror-image. However, the picture will be normal when recorded.

During recording in the mirror mode

While recording in the mirror mode, you cannot operate the following buttons: ZERO SET MEMORY on the Remote Commander and MENU on your camcorder.

Indicators in the mirror mode

The STBY indicator appears as **II●** and REC as **●**. Some of the other indicators appear mirror-reversed and others are not displayed.

After recording

- (1) Turn STANDBY down to LOCK.
- (2) Close the LCD panel.
- (3) Eject the cassette.
- (4) Set the POWER switch to OFF.

Recording a picture

To record pictures with the viewfinder – adjusting the viewfinder

If you record pictures with the LCD panel closed, check the picture with the viewfinder. Adjust the viewfinder lens to your eyesight so that the indicators in the viewfinder come into sharp focus.

Lift up the viewfinder and move the viewfinder lens adjustment lever.

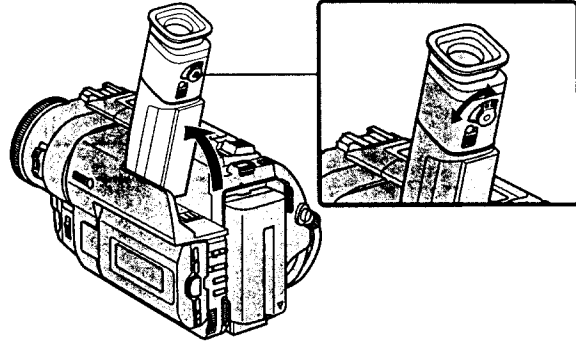

Recording a picture

Using the zoom feature

Move the power zoom lever a little for a slower zoom. Move it further for a faster zoom. Using the zoom function sparingly results in better-looking recordings.

"T" side: for telephoto (subject appears closer)

"W" side: for wide-angle (subject appears farther away)

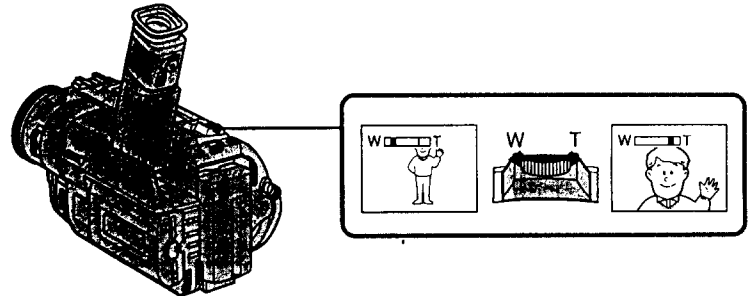

Zoom greater than 20× is performed digitally, if you set D ZOOM to ON in the MENU settings. The digital zoom function is set OFF at the factory (p. 53).

The right side of the bar shows the digital zooming zone.
The digital zooming zone appears when you set D ZOOM to ON.

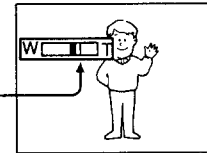

When you shoot close to a subject

If you cannot get a sharp focus, move the power zoom lever to the "W" side until the focus is sharp. You can shoot a subject that is at least about 2 feet 5/8 inch (about 80 cm) away from the lens surface in the telephoto position, or about 1/2 inch (about 1 cm) away in the wide-angle position.

Notes on digital zoom

- Digital zoom starts to function when zoom exceeds 20×.
- The picture quality deteriorates as you go toward the "T" side. Set D ZOOM to OFF in the MENU settings. Otherwise the digital zoom activates without notice (p. 53).

Recording a picture

START/STOP MODE setting

: Recording starts when you press START/STOP, and stops when you press it again (factory setting).

ANTI GROUND SHOOTING : The camcorder records only while you press START/STOP. Use this mode to avoid recording unnecessary scenes.

5SEC: When you press use this mode to START/STOP, your camcorder records for 5 seconds and then stops automatically.

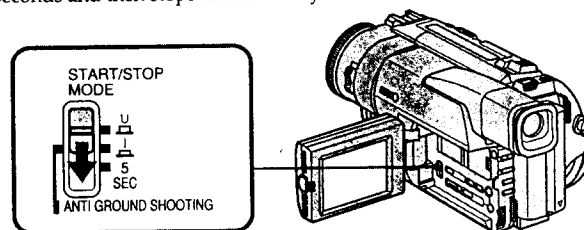

Notes

- You cannot use the fader function in the 5SEC or  mode.
- The time code does not appear in the 5SEC mode.

To extend the recording time in the 5SEC mode

Five dots (●●●●●) appear, and then disappear at a rate of one per second. To extend the recording time, press START/STOP again before all the dots disappear. Recording continues for about 5 seconds from the moment you press START/STOP.

Indicators displayed in the recording mode

The indicators are not recorded on tape.

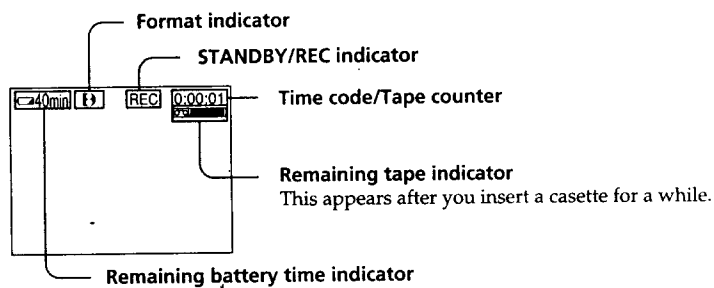

Time code (for tapes recorded in the Digital8 system only)

The time code indicates the recording or playback time, "0:00:00" (hours:minutes:seconds) in CAMERA mode and "0:00:00:00" (hours:minutes:seconds:frames) in VTR mode. You cannot rewrite only the time code. Your camcorder uses the drop frame mode.

When you play back tapes recorded in the Hi8/standard 8 system, the tape counter appears.

Recording a picture

Shooting backlit subjects (BACK LIGHT)

When you shoot a subject with the light source behind the subject or a subject with a light background, use the backlight function.

Press BACK LIGHT in the recording or standby mode.
The  indicator appears in the viewfinder or on the LCD screen.
To cancel, press BACK LIGHT again.

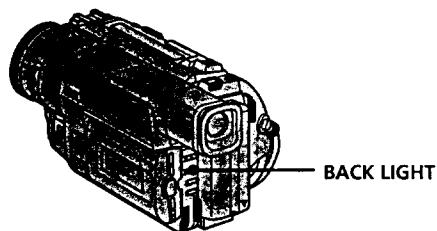

If you press EXPOSURE when shooting backlit subjects
The backlight function will be canceled.

Shooting in the dark (NightShot)

The NightShot function enables you to shoot a subject in a dark place. For example, you can satisfactorily record the environment of nocturnal animals for observation when you use this function.

- (1) While your camcorder is in the standby mode, slide NIGHTSHOT to ON.
- (2) Press START/STOP to start recording.
 and "NIGHTSHOT" indicators flash on the LCD screen or in the viewfinder. To cancel the NightShot function, slide NIGHTSHOT to OFF.

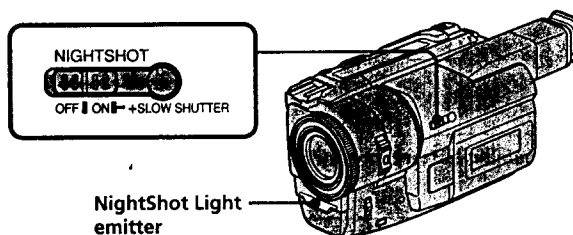





Recording a picture

Using +SLOW SHUTTER

The NightShot +Slow shutter mode makes subjects more than four times brighter than those recorded in the NightShot mode.

- (1) Slide NIGHTSHOT to ON in the standby mode.  indicator appears.
- (2) Press +SLOW SHUTTER until the desired NIGHTSHOT indicator flashes.

The indicator changes as follows:

 (NIGHTSHOT) →  (NIGHTSHOT1) →  (NIGHTSHOT2) →  (NIGHTSHOT)

To cancel the NightShot +Slow shutter mode, slide NIGHTSHOT to OFF.

Using the NightShot Light

The picture will be clearer with the NightShot Light on. To enable NightShot Light, set N.S.LIGHT to ON in the MENU settings (p. 53).

Notes



- Do not use the NightShot function in bright places (ex. outdoors in the daytime). This may cause your camcorder to malfunction.
- When you keep NIGHTSHOT set to ON in normal recording, the picture may be recorded in incorrect or unnatural colors.
- If focusing is difficult with the autofocus mode when using the NightShot function, focus manually.

While using the NightShot function, you can not use the following functions:

- Exposure
- PROGRAM AE
- Fader*
- Digital effect*

* You cannot use these functions only in the NightShot +Slow shutter mode.

Shutter speed in the NightShot +Slow shutter mode

Indicator	Shutter speed
 (NIGHTSHOT1)	1/15
 (NIGHTSHOT2)	1/4

The +SLOW SHUTTER button does not work:

- while the fader function is set or in use
- while the digital effect function is in use
- when NIGHTSHOT is set to OFF

NightShot Light

NightShot Light rays are infrared and so are invisible. The maximum shooting distance using the NightShot Light is about 10 feet (3 m). The shooting distance will be twice or more in the NightShot +Slow shutter mode.

Checking the recording

- END SEARCH / EDITSEARCH / Rec Review

You can use these buttons to check the recorded picture or shoot so that the transition between the last recorded scene and the next scene you record is smooth.

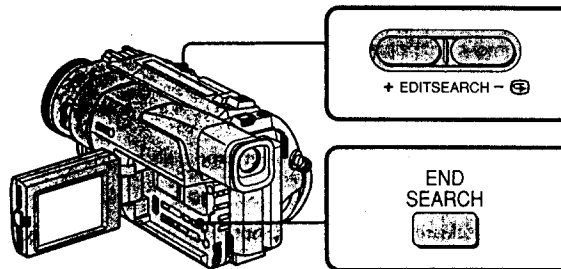

END SEARCH

You can go to the end of the recorded section after you record.

Press END SEARCH in the standby mode.

The last 5 seconds of the recorded section are played back and playback stops. You can monitor the sound from the speaker or headphones.

EDITSEARCH

You can search for the next recording start point.

Hold down the +/- (⊖) side of EDITSEARCH in the standby mode. The recorded section is played back.

- + : to go forward
- : to go backward

Release EDITSEARCH to stop playback. If you press START/STOP, re-recording begins from the point you released EDITSEARCH. You cannot monitor the sound.

Rec Review

You can check the last recorded section.

Press the - (⊖) side of EDITSEARCH momentarily in the standby mode.

The last few seconds of the recorded section are played back. You can monitor the sound from the speaker or headphones.

Notes

- END SEARCH, EDITSEARCH and Rec Review work only for tapes recorded in the Digital8 (8) system.
- If you start recording after using the end search function, occasionally, the transition between the last scene you recorded and the next scene may not be smooth.
- The end search function may not work when there is a blank portion between pictures on a tape.

Once you eject the cassette after you have recorded on the tape

The end search function does not work.

Playing back a tape

You can monitor the playback picture on the LCD screen or in the viewfinder. You can control playback using the Remote Commander supplied with your camcorder.

- (1) Install the power source and insert the recorded tape.
- (2) Set the POWER switch to VTR while pressing the small green button. The video control buttons light up.
- (3) Open the LCD panel while pressing OPEN.
- (4) Press ◀◀ to rewind the tape.
- (5) Press ▶▶ to start playback.
- (6) To adjust the volume, press either of the two buttons on VOLUME. The speaker on your camcorder is silent when the LCD panel is closed.

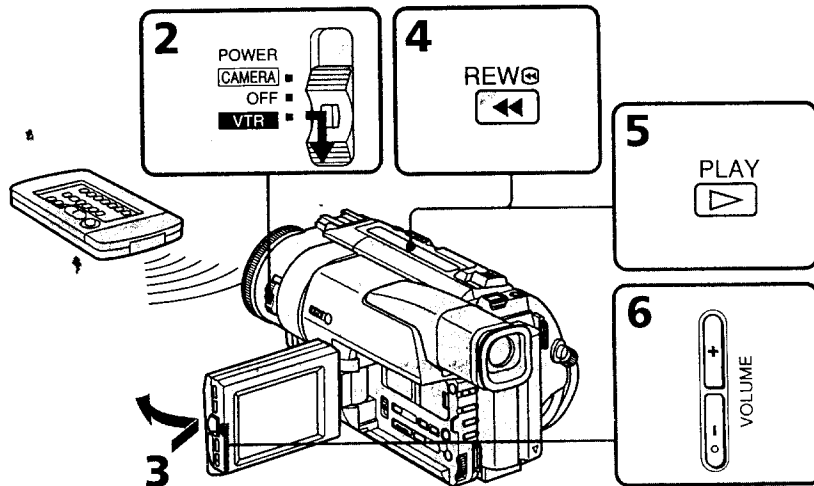

To stop playback

Press ■.

When monitoring on the LCD screen

You can turn the LCD panel over and move it back to the camcorder body with the LCD screen facing out [a]. You can adjust the angle of the LCD panel by lifting the LCD panel up by 15 degrees [b].

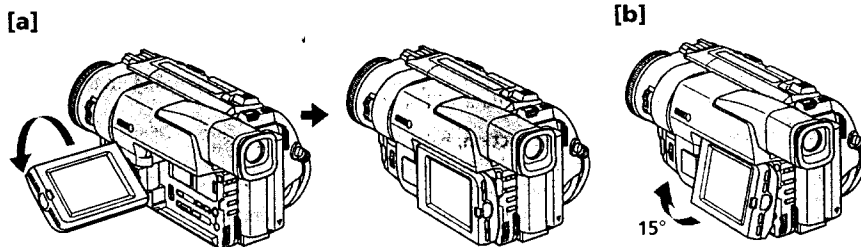

Playing back a tape

To display the screen indicators = Display function

Press DISPLAY on your camcorder or the Remote Commander supplied with your camcorder.

The indicators appear on the LCD screen.

To make the indicators disappear, press DISPLAY again.

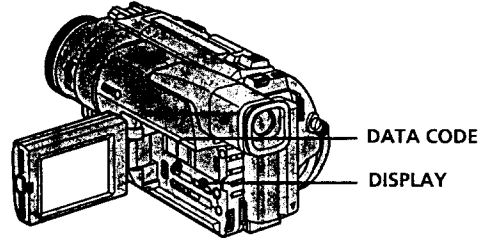

Using the data code function

Your camcorder automatically records not only images on the tape but also the recording data (date/time or various settings when recorded) (**Data code function**).

Press DATA CODE on your camcorder or the Remote Commander in the playback mode.

The display changes as follows:

date/time → various settings (SteadyShot, exposure AUTO/MANUAL, white balance, gain, shutter speed, aperture value) → no indicator

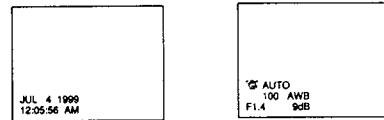

Not to display recording date

Set DATA CODE to DATE in the MENU settings (p. 53)

The display changes as follows:

date/time → no indicator

Note on the data code function

The data code function works only for tapes recorded in the Digital8  system.

Recording data

Recording data is your camcorder's information when you have recorded. In the recording mode, the recording data will not be displayed.

When you use data code function, bars (---) appear if:

- A blank section of the tape is being played back.
- The tape is unreadable due to tape damage or noise.
- The tape was recorded by a camcorder without the date and time set.

Playing back a tape

Various playback modes

To operate control buttons, set the POWER switch to VTR.

To view a still picture (playback pause)

Press **II** during playback. To resume playback, press **II** or **▶**.

To advance the tape

Press **▶▶** in the stop mode. To resume normal playback, press **▶**.

To rewind the tape

Press **◀◀** in the stop mode. To resume normal playback, press **▶**.

To change the playback direction

Press **<** on the Remote Commander during playback to reverse the playback direction. To resume normal playback, press **▶**.

To locate a scene monitoring the picture (picture search)

Keep pressing **◀◀** or **▶▶** during playback. To resume normal playback, release the button.

To monitor the high-speed picture while advancing or rewinding the tape (skip scan)

Keep pressing **◀◀** while rewinding or **▶▶** while advancing the tape. To resume rewinding or advancing, release the button.

To view the picture at slow speed (slow playback)

Press **▶** on the Remote Commander during playback. For slow playback in the reverse direction, press **<**, then press **▶** on the Remote Commander. To resume normal playback, press **▶**.

To view the picture at double speed

Press **x2** on the Remote Commander during playback. For double speed playback in the reverse direction, press **<**, then press **x2** on the Remote Commander. To resume normal playback, press **▶**.

To view the picture frame-by-frame

Press **II▶** on the Remote Commander in the playback pause mode. For frame-by-frame playback in the reverse direction, press **◀II**. To resume normal playback, press **▶**.

To search the last scene recorded (END SEARCH)

Press **END SEARCH** in the stop mode. The last 5 seconds of the recorded section plays back and stops.

In the various playback modes

- Noise may appear when your camcorder plays back tapes recorded in the Hi8/standard 8 system.
- Sound is muted.
- The previous recording may appear as a mosaic image when playing back in the Digital8 **▶** system.

When the playback pause mode lasts for 3 minutes

- Your camcorder automatically enters the stop mode. To resume playback, press **▶**.
- The previous recording may appear.

Slow playback for tapes recorded in the Digital8 **▶** system

The slow playback can be performed smoothly on your camcorder; however, this function does not work for an output signal from the **▶** DV IN/OUT jack.

Viewing the recording on TV

Connect your camcorder to your TV or VCR with the A/V connecting cable supplied with your camcorder to watch the playback picture on the TV screen. You can operate the playback control buttons in the same way as when you monitor playback pictures on the LCD screen. When monitoring the playback picture on the TV screen, we recommend that you power your camcorder from a wall outlet using the AC power adaptor (p. 11). Refer to the operating instructions of your TV or VCR.

Open the jack cover. Connect your camcorder to the TV using the A/V connecting cable. Then, set the TV/VCR selector on the TV to VCR.

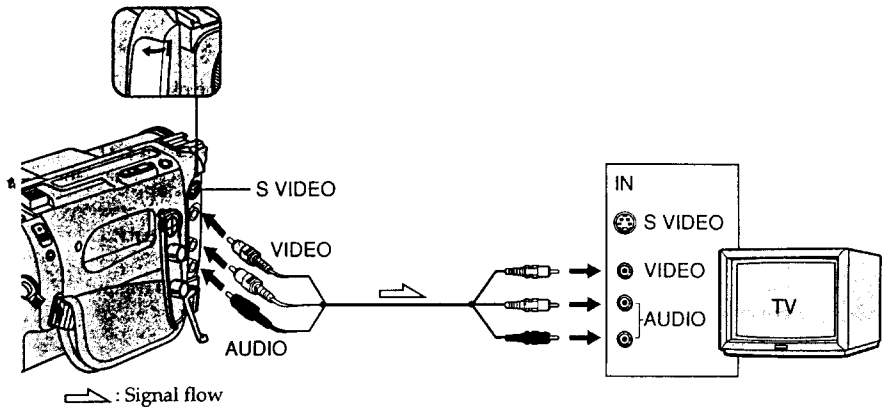

If your TV is already connected to a VCR

Connect your camcorder to the LINE IN input on the VCR by using the A/V connecting cable supplied with your camcorder. Set the input selector on the VCR to LINE.

If your TV or VCR is a monaural type

Connect the yellow plug for video and the white plug for audio on both your camcorder and the TV or the VCR (you do not connect the red plug). With this connection, the sound is monaural even on stereo models.

To connect to a TV or VCR without Video/Audio input jacks

Use an NTSC system RFU adaptor (not supplied). Refer to the operating instructions of your TV or VCR and the RFU adaptor. With an RFU adaptor, the sound is monaural.

If your TV or VCR has an S video jack

Connect using an S video cable (not supplied) to obtain high-quality pictures. With this connection, you do not need to connect the yellow (video) plug of the A/V connecting cable.

Connect the S video cable (not supplied) to the S video jacks on both your camcorder and the TV or the VCR.

Viewing the recording on TV

Using the AV cordless IR receiver

Once you connect the AV cordless IR receiver (not supplied) to your TV or VCR, you can easily view the picture on your TV. For details, refer to the operating instructions of the AV cordless IR receiver.

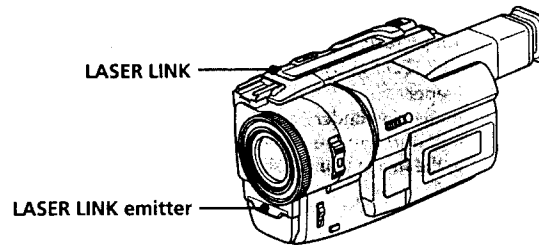

- (1) After connecting your TV and AV cordless IR receiver, set the POWER switch on the AV cordless IR receiver to ON.
- (2) Turn the TV on and set the TV/VCR selector on the TV to VCR.
- (3) Press LASER LINK. The lamp of LASER LINK lights up.
- (4) Press ► on your camcorder to start playback.
- (5) Point the LASER LINK emitter at the AV cordless IR receiver. Adjust the position of your camcorder and the AV cordless IR receiver to obtain clear playback pictures.

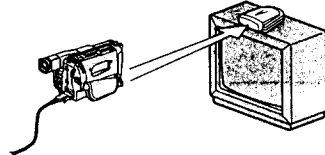

To cancel the laser link function

Press LASER LINK. The lamp on the LASER LINK button goes out.

If you turn the power off

Laser link turns off automatically.

If you use a Sony TV

- You can turn on the TV automatically when you press LASER LINK or ►. To do so, set AUTO TV ON to ON in the MENU settings and turn the TV's main switch on, then do either of the following:
 - Point the LASER LINK emitter at the TV's remote sensor and press LASER LINK.
 - Turn on LASER LINK and press ►.
- You can switch the video input of the TV automatically to the one which the AV cordless IR receiver is connected. To do so, set AUTO TV ON to ON and TV INPUT to the same video input (1, 2, 3) in the MENU settings. With some models, however, the picture and sound may be disconnected momentarily when the video input is switched.
- The above feature may not work on some TV models.

Note

When laser link is activated (the LASER LINK button is lit), your camcorder consumes power. Press LASER LINK to turn off the laser link function when it is not needed.

Photo recording

You can record a still picture like a photograph. This mode is useful when you want to record a picture such as a photograph or when you print a picture using a video printer (not supplied).

(1) Set the POWER switch to CAMERA.

(2) In the standby mode, keep pressing PHOTO lightly until a still picture appears. The CAPTURE indicator appears. Recording does not start yet.

To change the still picture, release PHOTO, select a still picture again, and then press and hold PHOTO lightly.

(3) Press PHOTO deeper.

The still picture in the viewfinder or on the LCD screen is recorded for about seven seconds. The sound during those seven seconds is also recorded.

During recording, the image you are shooting appears in the viewfinder or on the LCD screen.

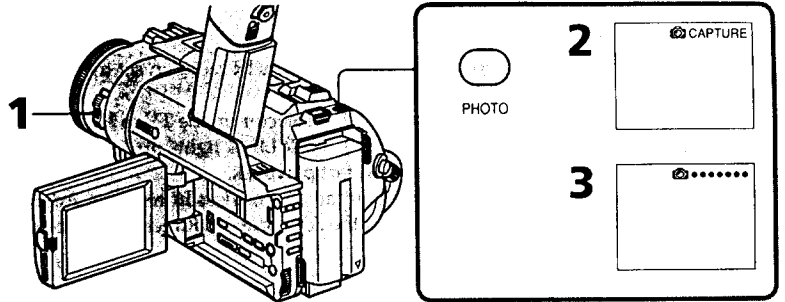

Notes

- During photo recording, you cannot change the mode or setting.
- During photo recording, you cannot turn your camcorder off or press the PHOTO button.
- The PHOTO button does not work:
 - while the digital effect function is set or in use.
 - while the fader function is in use.
- When recording a still picture, do not shake your camcorder. The picture may fluctuate.

To use photo recording function using the Remote Commander

Press PHOTO in the Remote Commander. Your camcorder record a picture on the LCD screen or in the viewfinder immediately.

To use the photo recording function during normal CAMERA recording

Press PHOTO deeper. The still picture is then recorded for about seven seconds and your camcorder returns to the standby mode. You cannot select another still picture.

Photo recording

Printing the still picture

You can print a still picture by using the video printer (not supplied). Connect the video printer using the A/V connecting cable supplied with your camcorder. Connect the yellow plug of the cable to the VIDEO jack and to the video input of the video printer. Refer to the operating instructions of the video printer as well.

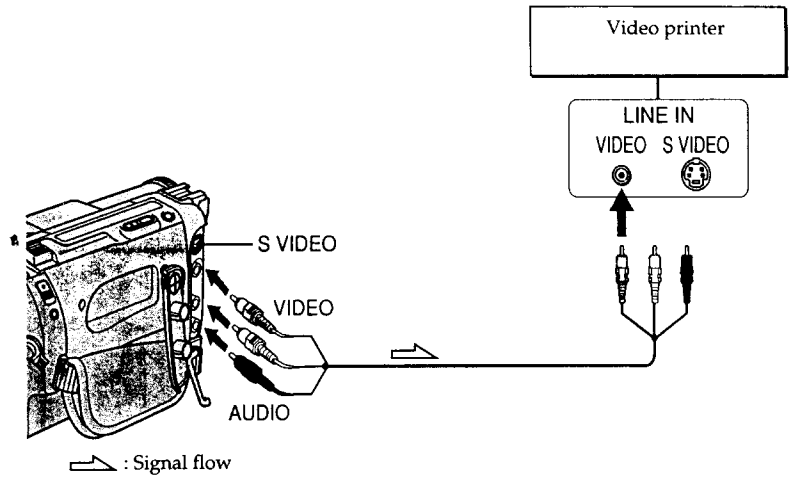

If the video printer is equipped with S video input

Use the S video connecting cable (not supplied). Connect it to the S VIDEO jack and the S video input of the video printer.

Using the wide mode

You can record a 16:9 wide picture to watch on the 16:9 wide-screen TV (16:9 WIDE). The picture with black bands at the top and the bottom on the LCD screen [a] is normal. The picture on a normal TV or in the viewfinder [b] is horizontally compressed. You can watch the picture of normal images on a wide-screen TV [c].

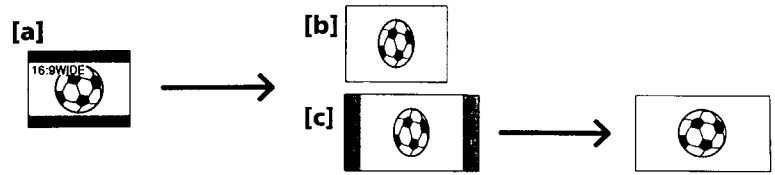

In the standby mode, set 16:9WIDE to ON in the MENU settings (p. 53).

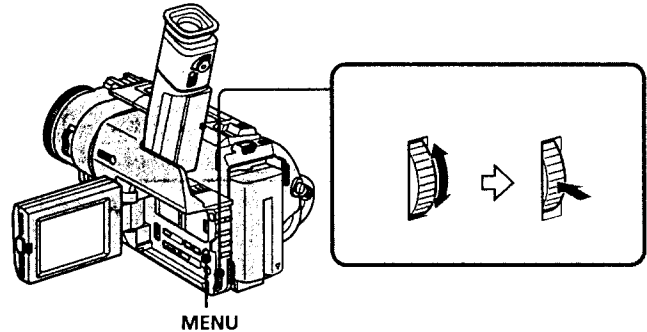

To cancel the wide mode

Set 16:9WIDE to OFF in the MENU settings.

If the wide mode is set to ON

The SteadyShot function does not work. If you set 16:9WIDE to ON in the MENU settings when the SteadyShot function is working, "SS" flashes and the SteadyShot function does not function.

In the wide mode

You cannot select the old movie function with DIGITAL EFFECT and the bounce function with FADER.

During recording

You cannot select or cancel the wide mode.

Connection for a TV

Pictures recorded in the 16:9WIDE mode automatically appear on the TV screen at full size when:

- you connect your camcorder to a TV that is compatible with the video ID (ID-1/ID-2) system.
- you connect your camcorder to the S video jack on the TV.

ID-2 system

The ID-2 system is a system which converts the copyright signal to the analog system with ID-1 signals inserted between video signals.

Using the fader function

You can fade in or out to give your recording a professional appearance.

[a] **STBY** **REC**

FADER				
M.FADER (mosaic)				
* BOUNCE* (Fade in only)				
QVERLAP (Fade in only)				

[b] **STBY** **REC**

Advanced Recording Operations

MONOTONE

When fading in, the picture gradually changes from black-and-white to color.
When fading out the picture gradually changes from color to black-and-white.

* You cannot use this function when D ZOOM is set to ON in the MENU settings.

Using the fader function

(1) When fading in [a]

In the standby mode, press FADER until the desired fader indicator flashes.

When fading out [b]

In the recording mode, press FADER until the desired fader indicator flashes.

The indicator changes as follows:

FADER → M.FADER → BOUNCE → MONOTONE → OVERLAP →
no indicator

The last selected fader mode is indicated first of all.

(2) Press START/STOP. The fader indicator stops flashing.

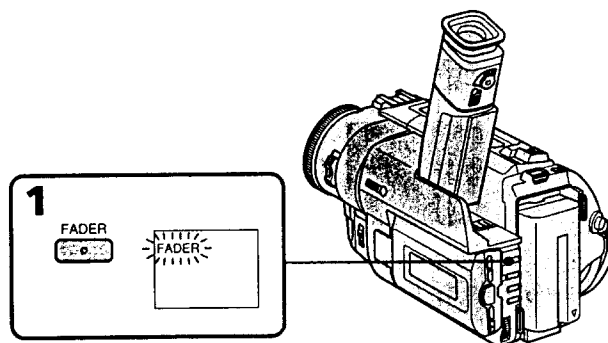

To cancel the fader function

After the fade in/out is carried out : Your camcorder automatically returns to the normal mode.

Before the fade in/out is carried out : Before pressing START/STOP, press FADER until the indicator disappears.

Using the Fader function

Notes

- The overlap function works only for tapes recorded in the Digital8 (D) system.
- You cannot use the following functions while using the fader function. Also, you cannot use the fader function while using the following functions.
 - Digital effect
 - Low lux mode of PROGRAM AE (Overlap function only)
 - NightShot +Slow shutter
 - Photo recording

When the OVERLAP indicator appears

The camcorder automatically memorizes the image recorded on a tape. As the image is being memorized, the OVERLAP indicator flashes fast, and the playback picture is displayed. At this stage, the picture may not be recorded clearly, depending on the tape condition.

When START/STOP MODE is set to \perp or 5SEC

You cannot use the fader function.

While using the bounce function, you cannot use the following functions:

- Exposure
- Focus
- Zoom
- Picture effect

Note on the bounce function

The BOUNCE indicator does not appear in the following mode or functions:

- D ZOOM is set to ON in the MENU settings
- Wide mode
- Picture effect
- PROGRAM AE

Using special effects – Picture effect

You can digitally process images to obtain special effects like those in films or on the TV.

NEG. ART [a] : The color and brightness of the picture is reversed.

SEPIA : The picture is sepia.

B&W : The picture is monochrome (black-and-white).

SOLARIZE [b] : The light intensity is clearer, and the picture looks like an illustration.

SLIM [c] : The picture expands vertically.

STRETCH [d] : The picture expands horizontally.

PASTEL [e] : The contrast of the picture is emphasized, and the picture looks like an animated cartoon.

MOSAIC [f] : The picture is mosaic.



(1) Press PICTURE EFFECT in the standby or recording mode.
The picture effect indicator appears.

(2) Turn the SEL/PUSH EXEC dial to select the desired picture effect mode.
The indicator changes as follows:

NEG.ART ↔ SEPIA ↔ B&W ↔ SOLARIZE ↔ SLIM ↔ STRETCH ↔
PASTEL ↔ MOSAIC

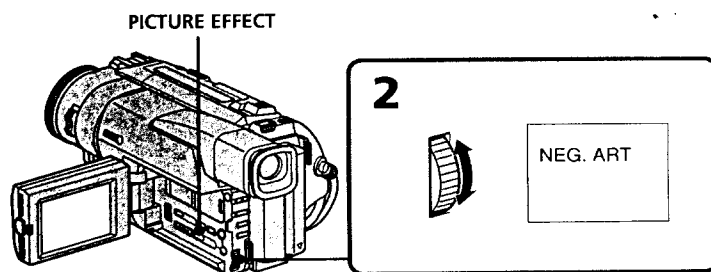

To turn the picture effect function off

Press PICTURE EFFECT.

While using the picture effect function

You cannot select the old movie mode with DIGITAL EFFECT.

When you turn the power off

Your camcorder automatically returns to the normal mode.

Using special effects – Digital effect

You can add special effects to recorded pictures using the various digital functions. The sound is recorded normally.

STILL

You can record a still picture so that it is superimposed on a moving picture.

FLASH (FLASH MOTION)

You can record still pictures successively at constant intervals.

LUMI. (LUMINANCEKEY)

You can swap a brighter area in a still picture with a moving picture.

TRAIL

You can record the picture so that an incidental image like a trail is left.

SLOW SHTR (SLOW SHUTTER)

You can slow down the shutter speed. The slow shutter mode is good for recording dark pictures more brightly. However, the picture may be less clear.

OLD MOVIE

You can add an old movie type atmosphere to pictures. Your camcorder automatically sets the wide mode to ON, picture effect to SEPIA, and the appropriate shutter speed.

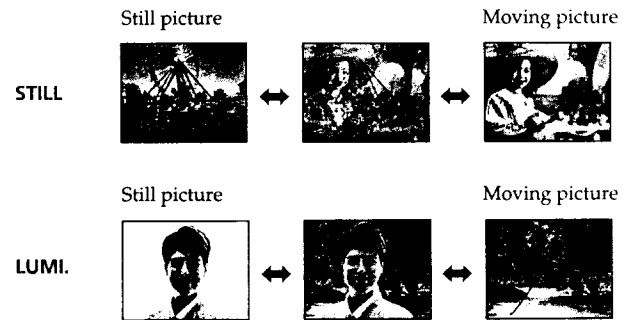

Using special effects – Digital effect

- (1) While your camcorder is in the standby or recording mode, press DIGITAL EFFECT. The digital effect indicator appears.
- (2) Turn the SEL/PUSH EXEC dial to select the desired digital effect mode.
The indicator changes as follows:
STILL ↔ FLASH ↔ LUMI. ↔ TRAIL ↔ SLOW SHTR ↔ OLD MOVIE
- (3) Press the SEL/PUSH EXEC dial. The indicator lights up and the bars appear.
In the STILL and LUMI. modes, the still picture is stored in memory.
- (4) Turn the SEL/PUSH EXEC dial to adjust the effect.

Items to adjust

STILL	The rate of the still picture you want to superimpose on the moving picture
FLASH	The interval of flash motion
LUMI.	The color scheme of the area in the still picture which is to be swapped with a moving picture
TRAIL	The vanishing time of the incidental image
SLOW SHTR	Shutter speed. The larger the shutter speed number, the slower the shutter speed.
OLD MOVIE	No adjustment necessary

The more bars there are on screen, the stronger the digital effect. The bars appear in the following modes: STILL, FLASH, LUMI. and TRAIL.

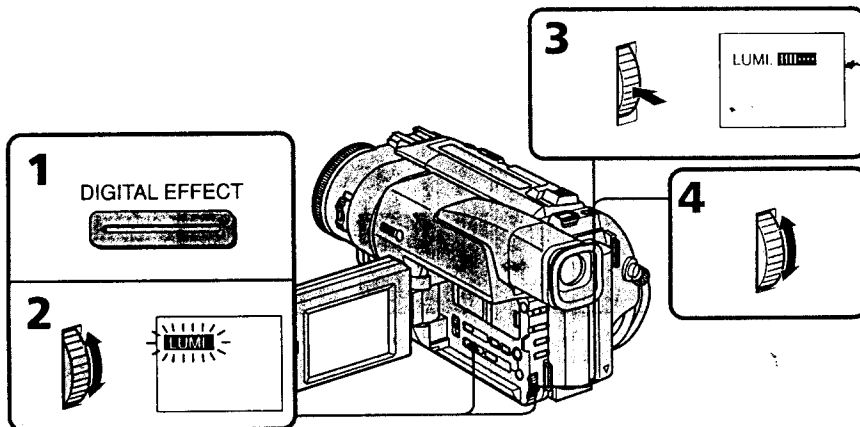

To cancel the digital effect

Press DIGITAL EFFECT. The digital effect indicator disappears.

Using special effects – Digital Effect

Notes

- The following functions do not work during digital effect:
 - Fader
 - Low lux mode of PROGRAM AE
 - Photo recording
 - NightShot +Slow shutter
- The following functions do not work in the slow shutter mode:
 - Exposure
 - PROGRAM AE
- The following functions do not work in the old movie mode:
 - Exposure
 - Wide mode
 - Picture effect
 - PROGRAM AE

When you turn the power off

The digital effect will be automatically canceled.

When recording in the slow shutter mode

Auto focus may not be effective. Focus manually using a tripod.

Shutter speed

Shutter speed number	Shutter speed
SLOW SHTR 1	1/30
SLOW SHTR 2	1/15
SLOW SHTR 3	1/8
SLOW SHTR 4	1/4

Using the PROGRAM AE function

You can select PROGRAM AE (Auto Exposure) mode to suit your specific shooting requirements.

Spotlight mode

This mode prevents people's faces, for example, from appearing excessively white when shooting subjects lit by strong light at weddings or in the theater.

Soft portrait mode

This mode brings out the subject while creating a soft background for subjects such as people or flowers, and faithfully reproduces skin color.

Sports lesson mode

This mode minimizes shake on fast-moving subjects such as in tennis or golf.

Beach & ski mode

This mode prevents people's faces from appearing dark in strong light or reflected light, such as at a beach in midsummer or on a ski slope.

Sunset & moon mode

This mode allows you to maintain atmosphere when you are recording sunsets, general night views, fireworks displays and neon signs.

Landscape mode

This mode is for when you are recording distant subjects such as mountains and prevents your camcorder from focusing on glass or metal mesh in windows when you are recording a subject behind glass or a screen.

Low lux mode

This mode makes subjects brighter in insufficient light.



Using the PROGRAM AE function

- (1) Press PROGRAM AE in the standby mode. The PROGRAM AE indicator appears.
- (2) Turn the SEL/PUSH EXEC dial to select the desired PROGRAM AE mode. The indicator changes as follows:

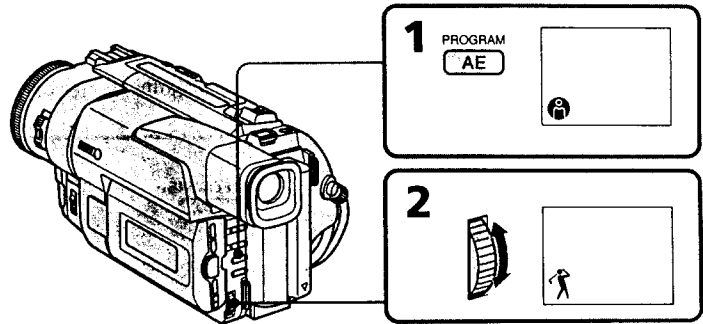
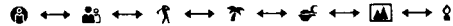

To turn the PROGRAM AE function off

Press PROGRAM AE.

Notes

- In the spotlight, sports lesson and beach & ski modes, you cannot take close-ups. This is because your camcorder is set to focus only on subjects in the middle to far distance.
- In the sunset & moon and landscape modes, your camcorder is set to focus only on distant subjects.
- The following functions do not work in the PROGRAM AE mode:
 - Slow shutter
 - Old movie
 - Bounce
- The following functions do not work in the low lux mode:
 - Digital effect
 - Overlap
 - Exposure
- If you press PROGRAM AE when using the NightShot function, the PROGRAM AE indicator flashes and the PROGRAM AE function does not work.

If you are recording under a discharge tube such as a fluorescent lamp, sodium lamp or mercury lamp

Flickering or changes in color may occur in the following modes. If this happens, turn the PROGRAM AE function off.

- Soft portrait mode
- Sports lesson mode

Adjusting the exposure manually

You can manually adjust and set the exposure. When you turn your camcorder on, it will automatically be in the automatic exposure mode. This mode works to record subjects so that they are recorded slightly brighter than they actually are.

Adjust the exposure manually in the following cases:

- The subject is backlit
- Bright subject and dark background
- To record dark pictures (e.g. night scenes) faithfully

(1) Press EXPOSURE in the standby or recording mode.

The exposure indicator appears.

(2) Turn the SEL/PUSH EXEC dial to adjust the brightness.

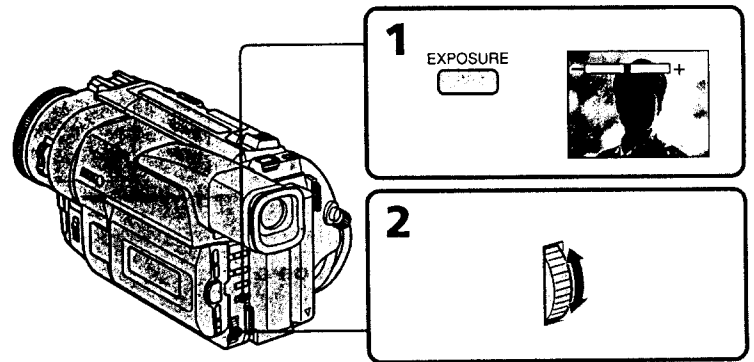

To return to the automatic exposure mode

Press EXPOSURE again.

Note

When you adjust the exposure manually, the following function and modes do not work:

- Backlight
- Slow shutter
- Old movie

If you change the PROGRAM AE mode or slide NIGHTSHOT to ON

Your camcorder automatically returns to the automatic exposure mode.

Focusing manually

You can gain better results by manually adjusting the focus in the following cases:

- The autofocus mode is not effective when shooting
 - subjects through glass coated with water droplets
 - horizontal stripes
 - subjects with little contrast with backgrounds such as walls and sky
- When you want to change the focus from a subject in the foreground to a subject in the background
- Shooting a stationary subject when using a tripod

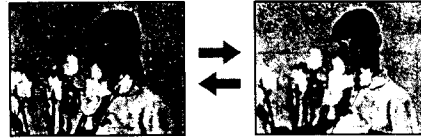

(1) Set FOCUS to MANUAL in the standby or recording mode. The  indicator appears.

(2) Turn the focus ring to sharpen focus.

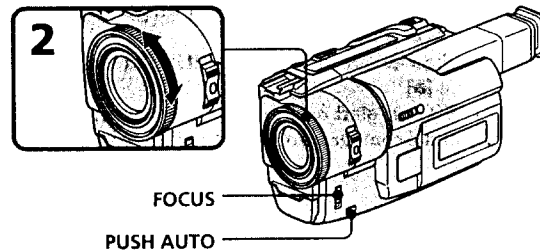

To return to the autofocus mode

Set FOCUS to AUTO.

To record distant subjects

When you press FOCUS down to INFINITY. The lens focuses on and  indicator appears. When you release FOCUS, your camcorder returns to the manual focus mode. Use this mode when your camcorder focuses on near objects even though you are trying to shoot a distant object.

To shoot with auto focusing momentarily

Press PUSH AUTO.

The auto focus functions while you are pressing PUSH AUTO.

Use this button to focus on one subject and then another with smooth focusing.

When you release PUSH AUTO, manual focusing resumes.



Shooting in relatively dark places or shooting fast-moving subjects in relatively bright places

Shoot at the "W" (wide-angle) position after focusing at the "T" (telephoto) position.

When you shoot close to the subject

Focus at the end of the "W" (wide-angle) position.

The following indicators may appear

-  when recording a distant subject.
-  when the subject is too close to focus on.

Inserting a scene

You can insert a scene in the middle of a recorded tape by setting the start and end points. The previously recorded frames between these start and end points will be erased. Use the Remote Commander for this operation.

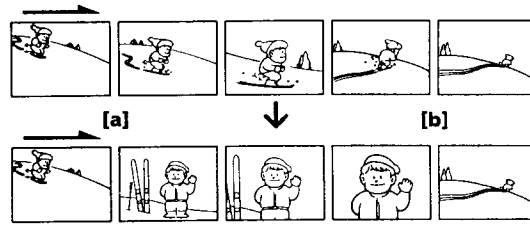

- (1) While your camcorder is in the standby mode, keep pressing EDITSEARCH, and release the button at the insert end point [b].
- (2) Press ZERO SET MEMORY. The ZERO SET MEMORY indicator flashes and the counter resets to zero.
- (3) Keep pressing the - ⊕ side of EDITSEARCH and release the button at the insert start point [a].
- (4) Press START/STOP to start recording. The scene is inserted. Recording stops automatically at the counter zero point. Your camcorder returns to the standby mode.

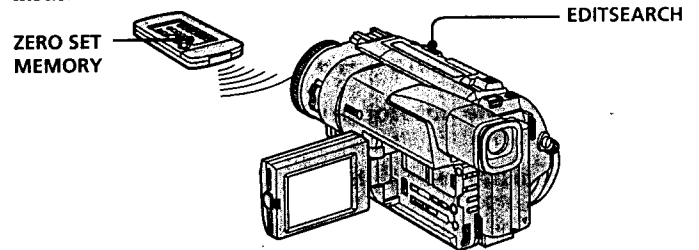

Notes

- The zero set memory function works only for tapes recorded in the Digital8 system.
- The picture and the sound may be distorted at the end of the inserted section when it is played back.

If you re-record on the section which contains a non-recorded section
The zero set memory function may not work correctly.

When START/STOP MODE is set to 1 or 5SEC
You cannot use the zero set memory function.

Playing back a tape with picture effects

During playback, you can process a scene using the picture effect functions: NEG.ART, SEPIA, B&W and SOLARIZE.

During playback, press PICTURE EFFECT and turn the SEL/PUSH EXEC dial until the desired picture effect indicator (NEG.ART, SEPIA, B&W or SOLARIZE) flashes.

For details of each picture effect function, see page 32.

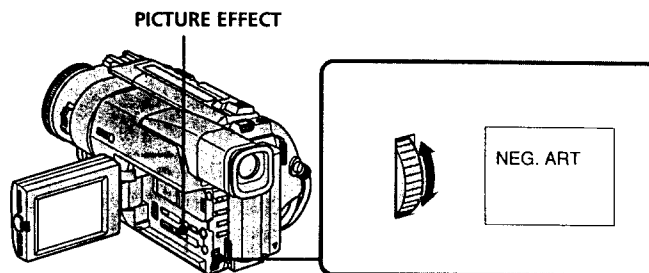

To cancel the picture effect function

Press PICTURE EFFECT.

Notes

- The picture effect function works only for tapes recorded in the Digital8  system.
- You cannot process externally input scenes using the picture effect function.
- To record pictures that you have processed using the picture effect function, record the pictures on the VCR.

Pictures processed by the picture effect function

Pictures processed by the picture effect function are not output through the  DV IN/OUT jack.

When you set the POWER switch to OFF or stop playing back

The picture effect function is automatically canceled.

Playing back a tape with digital effects

During playback, you can process a scene using the digital effect functions: STILL, FLASH, LUMI. and TRAIL.

- (1) During playback, press DIGITAL EFFECT and turn the SEL/PUSH EXEC dial until the desired digital effect indicator (STILL, FLASH, LUMI. or TRAIL) flashes.
- (2) Press the SEL/PUSH EXEC dial.
The digital effect indicator lights up and the bars appear. In the STILL or LUMI. mode, the picture where you press the SEL/PUSH EXEC dial is stored in memory as a still picture.
- (3) Turn the SEL/PUSH EXEC dial to adjust the effect.
For details of each digital effect function, see page 33.

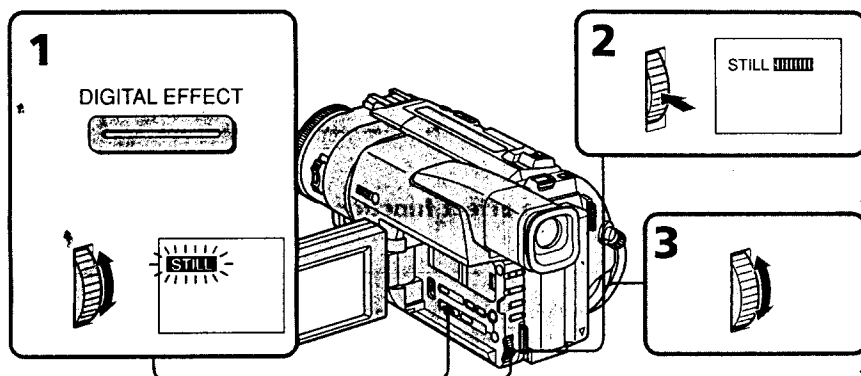

To cancel the digital effect function

Press DIGITAL EFFECT.

Notes

- The digital effect function works only for tapes recorded in the Digital8  system.
- You cannot process externally input scenes using the digital effect function.
- To record pictures that you have processed using the digital effect function, record the pictures on the VCR.

Pictures processed by the digital effect function

Pictures processed by the digital effect function are not output through the  DV IN/OUT jack.

When you set the POWER switch to OFF or stop playing back

The digital effect function is automatically canceled.

Quickly locating a scene using the zero set memory function

Your camcorder goes forward or backward to automatically stop at a desired scene having a counter value of "0:00:00". Use the Remote Commander for this operation. Use this function, for example, to view a desired scene later on during playback.

- (1) In the playback mode, press DISPLAY.
- (2) Press ZERO SET MEMORY at the point you want to locate later. The counter shows "0:00:00" and the ZERO SET MEMORY indicator flashes.
- (3) Press ■ when you want to stop playback.
- (4) Press ◀◀ to rewind the tape to the counter's zero point. The tape stops automatically when the counter reaches approximately zero. The ZERO SET MEMORY indicator disappears and the time code appears.
- (5) Press ▶▶. Playback starts from the counter's zero point.

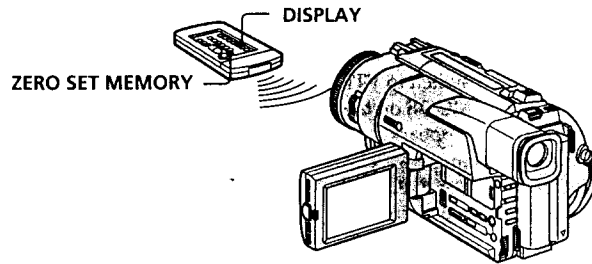

Notes

- The zero set memory function works only for tapes recorded in the Digital8 system.
- When you press ZERO SET MEMORY before rewinding the tape, the zero set memory function will be canceled.
- There may be a discrepancy of several seconds from the time code.
- The zero set memory function may not work when there is a blank portion between pictures on a tape.

Searching a recording by date

You can automatically search for the point where the recording date changes and start playback from that point (**Date search**). Use the Remote Commander for this operation. Use this function to check where recording dates change or to edit the tape at each recording date.

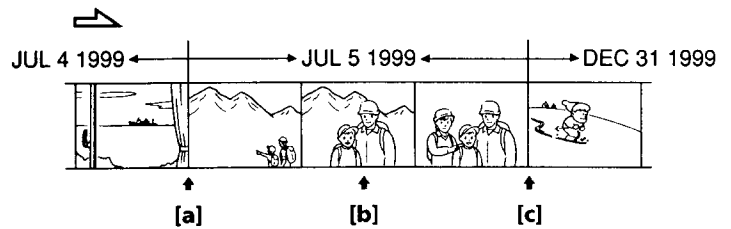

(1) Set the POWER switch to VTR.

(2) Press SEARCH MODE on the Remote Commander repeatedly, until the date search indicator appears.

The indicator changes as follows:

DATE SEARCH → PHOTO SEARCH → PHOTO SCAN → no indicator

(3) When the current position is [b], press ◀◀ to search towards [a] or press ▶▶ to search towards [c]. Your camcorder automatically starts playback at the point where the date changes.

Each time you press ◀◀ or ▶▶, the camcorder searches for the previous or next date.

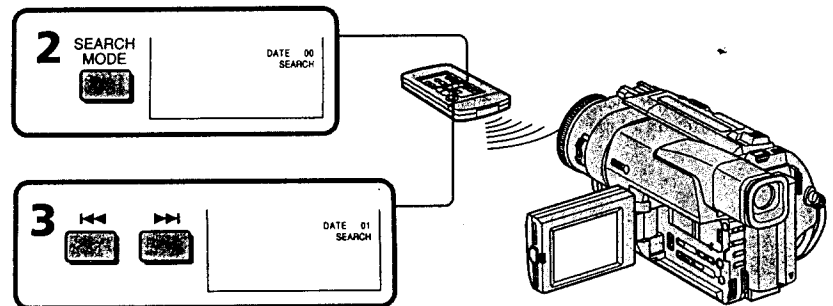

To stop searching

Press ■.

Searching a recording by date

Notes on the date search mode

- The date search works only for tapes recorded in the Digital8  system.
- If one day's recording is less than one minute, your camcorder may not accurately find the point where the recording date changes.

If a tape has a blank portion in the recorded portions

The date search function will not work correctly.

Searching for a photo – Photo search/ Photo scan

You can search for the recorded still picture (**photo search**).
You can also search for still pictures one after another and display each picture for five seconds automatically (**photo scan**). Use the Remote Commander for these operations.

Searching for a photo

- (1) Set the POWER switch to VTR.
- (2) Press SEARCH MODE on the Remote Commander repeatedly, until the photo search indicator appears.
The indicator changes as follows:
DATE SEARCH → PHOTO SEARCH → PHOTO SCAN → no indicator
- (3) Press ◀◀ or ▶▶ to select the photo for playback. Each time you press ◀◀ or ▶▶, the camcorder searches for the previous or next photo. Your camcorder automatically starts playback from the photo.

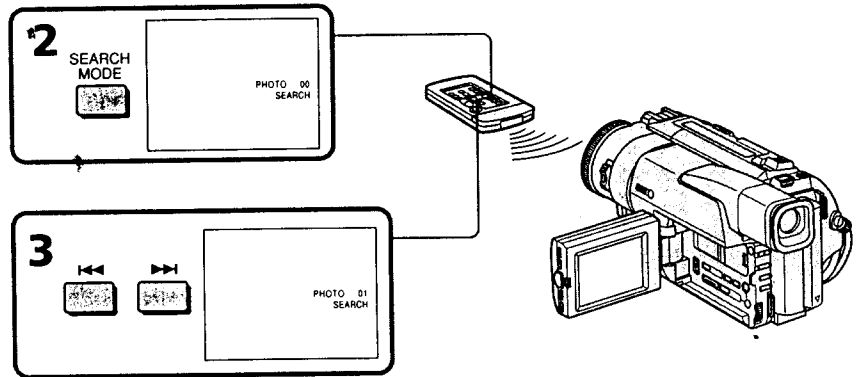

To stop searching

Press ■.

If a tape has a blank portion in the recorded portions
The photo search function may not work correctly.

Searching for a photo – Photo search/Photo scan

Scanning photo

- (1) Set the POWER switch to VTR.
- (2) Press SEARCH MODE on the Remote Commander repeatedly, until the photo scan indicator appears.
The indicator changes as follows:
DATE SEARCH → PHOTO SEARCH → PHOTO SCAN → no indicator
- (3) Press ◀◀ or ▶▶.
Each photo is played back for about 5 seconds automatically.

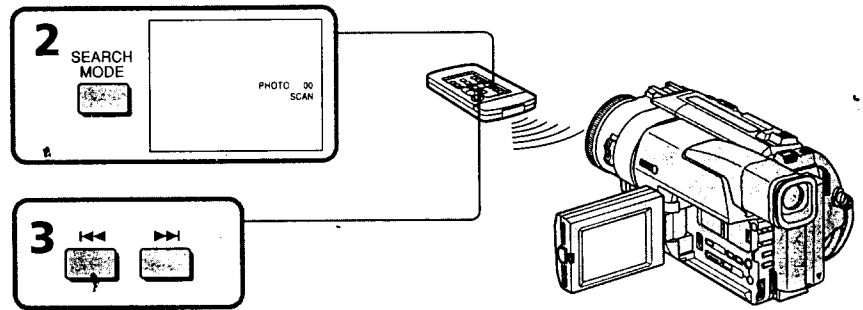

To stop scanning

Press ■.

Note

The photo search and photo scan work only for tapes recorded in the Digital8  system.

Dubbing a tape

Using the A/V connecting cable or S video connecting cable (not supplied)

Connect your camcorder to the VCR using the A/V connecting cable supplied with your camcorder.
Set the input selector on the VCR to LINE, if available.

- (1) Insert a blank tape (or a tape you want to record over) into the VCR, and insert the recorded tape into your camcorder.
- (2) Set the POWER switch to VTR.
- (3) Play back the recorded tape on your camcorder.
- (4) Start recording on the VCR.

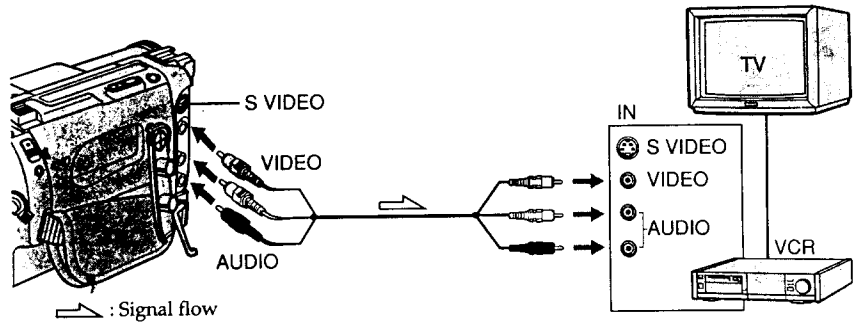

When you have finished dubbing a tape

Press **■** on both your camcorder and the VCR.

If you have displayed the screen indicators on the TV

Make the indicators disappear by pressing SEARCH MODE on the Remote Commander, DISPLAY or DATA CODE so that they will not be superimposed on the edited tape.

You can edit on VCRs that support the following systems

8 8 mm, **Hi8** Hi8, **VHS** VHS, **S-VHS** S-VHS, **VHS-C** VHS-C, **S-VHS-C** S-VHS-C, **B** Betamax, **ED Betamax** ED Betamax, **mini DV** mini DV, **DV** DV or **Digital8**

If your VCR is a monaural type

Connect the yellow plug for video and the white plug for audio on both your camcorder and the VCR. You do not need to connect the red plug. With this connection, the sound will be monaural.

Connect using an S video cable (not supplied) to obtain high-quality pictures

With this connection, you do not need to connect the yellow (video) plug of the A/V connecting cable.

Connect an S video cable (not supplied) to the S video jacks of both your camcorder and the VCR.

To perform a more precise editing

Connect a LANC cable (not supplied) to your camcorder and other video equipment having fine synchro-editing function, using this camcorder as a player.

Dubbing a tape

Using the i.LINK cable

Simply connect the VMC-IL4415/IL4435/2DV/4DV i.LINK cable (not supplied) to DV IN/OUT and to DV IN/OUT of the DV products. With digital-to-digital connection, video and audio signals are transmitted in digital form for high-quality editing. You cannot dub the screen indicators.

- (1) Insert a blank tape (or a tape you want to record over) into the VCR, and insert the recorded tape into your camcorder.
- (2) Set the POWER switch to VTR.
- (3) Play back the recorded tape on your camcorder.
- (4) Start recording on the VCR.

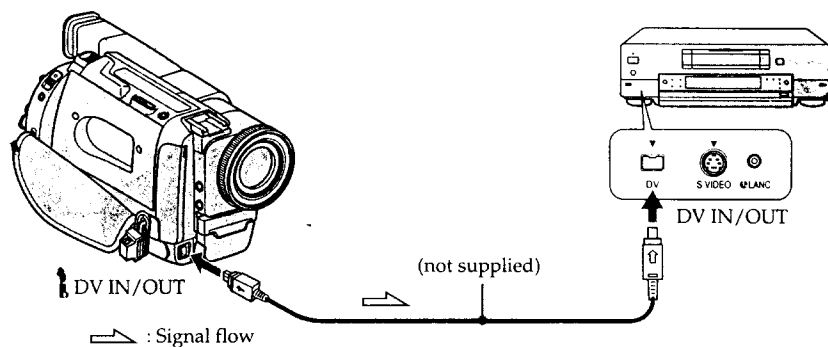

When you have finished dubbing a tape

Press **■** on both your camcorder and the VCR.

Note on tapes that are not recorded in the Digital8 system

The picture may fluctuate. This is not a malfunction.

During playback of tapes recorded in the Hi8/standard 8 system

Digital signals are output as the image signals from the  DV IN/OUT jack.

You can connect one VCR only using the i.LINK cable.

During digital editing

You cannot use DIGITAL EFFECT button functions.

You can also use your camcorder as a recorder

- You can use your camcorder as a player or recorder without changing the connection. In this case, the DV IN indicator appears in the viewfinder or on screen. The DV IN indicator may appear on both equipment.
- When using your camcorder as a recorder, the color balance may be incorrect on the monitor screen. This, however, is not recorded on the tape.

If you record playback pause picture via the DV jack

The recorded picture becomes rough. Also, when you play back the recorded pictures on other video equipment, the picture may jitter.

Recording video or TV programs

You can record a tape from another VCR or a TV program from a TV that has video/audio outputs. Use your camcorder as a recorder. Turn down the volume of your camcorder. Otherwise, the picture may be distorted.

- (1) Insert a blank tape (or a tape you want to record over) into your camcorder. If you are recording a tape from the VCR, insert a recorded tape into the VCR.
- (2) Set the POWER switch to VTR.
- (3) Set DISPLAY to LCD in the MENU settings (p. 53). The picture from a TV or VCR appears in the viewfinder or on the LCD screen.
- (4) Press ● REC and the button on its right simultaneously on your camcorder, then immediately press || on your camcorder.
- (5) Press ► on the VCR to start playback if you are recording a tape from VCR. Select a TV program if you are recording from TV.
- (6) Press || on your camcorder at the scene where you want to start recording from.

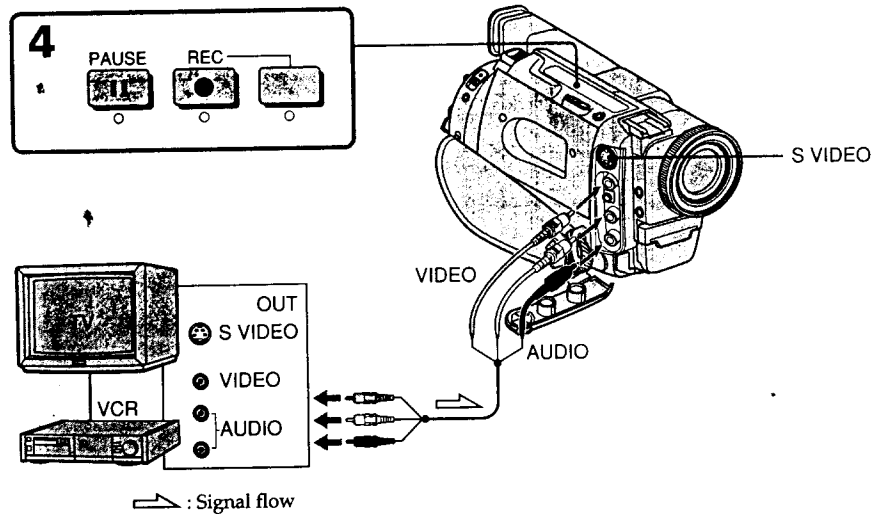

Notes

- To enable smooth transition, we recommend that you do not mix pictures recorded in the Hi8/standard 8 with the Digital8  system on a tape.
- If you fast-forward or slow-playback on the other equipment, the image being recorded may turn back and white. When recording from other equipment, be sure to play back the original tape at normal speed.

If your VCR is a monaural type

Connect the yellow plug for video and the white plug for audio on both your camcorder and the VCR (you do not need to connect the red plug). With this connection, the sound will be monaural.

Connect using an S video cable (not supplied) to obtain high-quality pictures
With this connection, you do not need to connect the yellow (video) plug of the A/V connecting cable.

Connect an S video cable (not supplied) to the S video jacks of both your camcorder and VCR.

If your VCR or TV does not have an S video out jack, do not connect an S video cable (not supplied) to your camcorder. If you connect an S video cable, the picture may not appear on screen.

Inserting a scene from a VCR

Replacing recording on a tape - Insert Editing

You can insert a new scene from a VCR onto your originally recorded tape by specifying the insert start and end points. Use the Remote Commander for this operation. Connections are the same as in "Recording video or TV programs" on page 50.

Insert a cassette containing the desired scene to insert into the VCR.

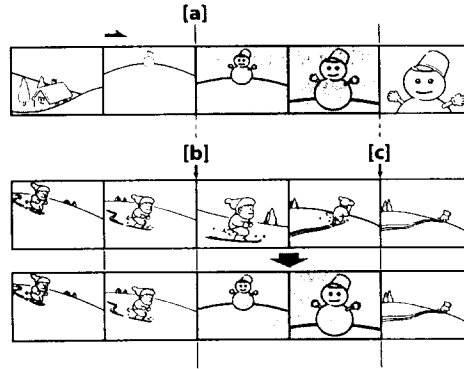

Inserting a scene from a VCR

- (1) Set the POWER switch to VTR.
- (2) On the VCR, locate just before the insert start point [a], then press **II** to set the VCR to the playback pause mode.
- (3) On your camcorder, locate the insert end point [c] by pressing **◀◀** or **▶▶**. Then press **II** to set it to the playback pause mode.
- (4) Press ZERO SET MEMORY on the Remote Commander. The ZERO SET MEMORY indicator flashes and the end point of the insert is stored in memory.
- (5) On your camcorder, locate the insert start point [b] by pressing **◀◀**, then press two **● REC** buttons at same time to set your camcorder to the recording pause mode.
- (6) First press **II** on the VCR, and after a few seconds press **II** on your camcorder to start inserting the new scene.

Inserting automatically stops near the zero point on the counter. Your camcorder automatically returns to the recording pause mode.

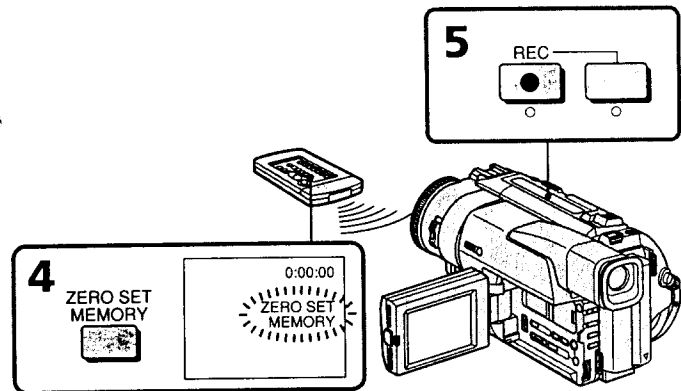

To change the insert end point

Press ZERO SET MEMORY again after step 5 to erase the ZERO SET MEMORY indicator and begin from step 3.

Notes

- The zero set memory function works only for tapes recorded in the Digital8 **Ⓜ** system.
- The picture and sound recorded on the section between the insert start and end points will be erased when you insert the new scene.

When the inserted picture is played back

The picture may be distorted at the end of the inserted section. This is not a malfunction.

To insert a scene without setting the insert end point

Skip step 3 and 4. Press **■** when you want to stop inserting.

Changing the MENU settings

To change the mode settings in the MENU settings, select the menu items with the SEL/PUSH EXEC dial. The factory settings can be partially changed. First, select the icon, then the menu item and then the mode.

- (1) In the standby or VTR mode, press MENU.
- (2) Turn the SEL/PUSH EXEC dial to select the desired icon, then press the dial to set.
- (3) Turn the SEL/PUSH EXEC dial to select the desired item, then press the dial to set.
- (4) Turn the SEL/PUSH EXEC dial to select the desired mode, and press the dial to set.
- (5) If you want to change other items, select ↻ RETURN and press the dial, then repeat steps from 2 to 4.

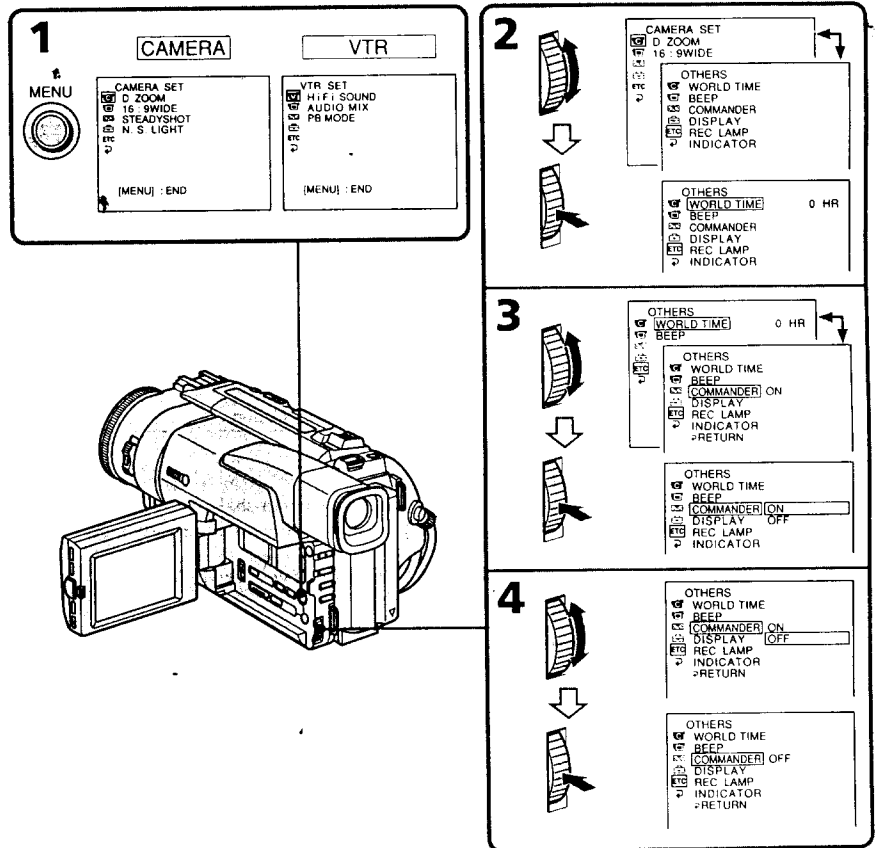







To make the MENU display disappear
Press MENU.

Changing the MENU settings

Note

When you let the subject monitor the shot (Mirror mode), the menu display does not appear.

Menu items are displayed as the following six icons:

-  CAMERA SET
-  VTR SET
-  LCD SET
-  TAPE SET
-  SETUP MENU
-  OTHERS

Selecting the mode setting of each item. ● is the factory setting.



Menu items differ according to whether the POWER switch is set to VTR or CAMERA.

Icon/item	Mode	Meaning	POWER switch
 D ZOOM	ON	To activate digital zoom. More than 20× to 360× zoom is performed digitally (p. 16)	CAMERA
	● OFF	To prevent the deterioration of the picture quality	
16:9WIDE	● OFF	—	CAMERA
	ON	To record a 16:9 wide picture (p. 28)	
STEADYSHOT	● ON	To compensate for camera-shake	CAMERA
	OFF	To cancel the SteadyShot function. Natural pictures are produced when shooting a stationary object with a tripod.	
N.S. LIGHT	● ON	To use the NightShot Light function (p. 19)	CAMERA
	OFF	To cancel the NightShot Light function	

Notes on the SteadyShot function

- The SteadyShot function will not correct excessive camera-shake.
- Attachment of a conversion lens (not supplied) may influence the SteadyShot function.
- SteadyShot does not operate in the 16:9WIDE mode. If you set STEADYSHOT to ON in the MENU settings, the  indicator flashes.

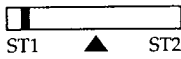
Changing the MENU settings

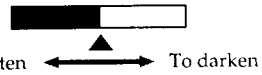
Icon/item	Mode	Meaning	POWER switch
 HiFi SOUND	● STEREO	To play back a stereo tape or dual sound track tape with main and sub sound	VTR
	1	To play back dual sound track tape with main sound	
	2	To play back a dual sound track tape with sub sound	
AUDIO MIX		To adjust the balance between the stereo 1 and stereo 2	VTR
			
PB MODE	● AUTO	To automatically select the system (Hi8/standard 8 or Digital8) that was used to record on the tape, and play back the tape	VTR
	Hi8/8	To play back a tape that was recorded in the Hi8/standard 8 system when your camcorder does not automatically distinguish the recording system	
 LCD B. L.	● BRT NORMAL	To set the brightness on the LCD screen normal	VTR CAMERA
	BRIGHT	To brighten the LCD screen	
LCD COLOR		To adjust the color on the LCD screen, turn and press the SEL/PUSH EXEC dial	VTR CAMERA
			

Notes on AUDIO MIX

- You can adjust the balance only for tapes recorded in the Digital8  system.
- When playing back a tape recorded in the 16-bit mode, you cannot adjust the balance.

Note on PB MODE

The mode will return to the factory setting when:

- you remove the battery pack or power source.
- you turn the POWER switch.

Notes on LCD B.L.

- When you select "BRIGHT", battery life is reduced by about 10 percent during recording.
- When you use power sources other than the battery pack, "BRIGHT" is automatically selected.

Changing the MENU settings

Icon/item	Mode	Meaning	POWER switch
AUDIO MODE	● 12BIT	To record or play back in the 12-bit mode (two stereo sounds)	VTR* CAMERA
	16BIT	To record or play back in the 16-bit mode (the one stereo sound with high quality)	
REMAIN	● AUTO	To display the remaining tape bar: <ul style="list-style-type: none"> • for about 8 seconds after your camcorder is turned on and calculates the remaining amount of tape • for about 8 seconds after a cassette is inserted and your camcorder calculates the remaining amount of tape • for about 8 seconds after ► is pressed in VTR mode • for about 8 seconds after DISPLAY is pressed to display the screen indicators • for the period of tape rewinding, forwarding or picture search in the VTR mode 	VTR CAMERA
	ON	To always display the remaining tape indicator	
DATA CODE	● DATE/CAM	To display date, time and recording data during playback	VTR
	DATE	To display date and time during playback	
CLOCK SET		To reset the date or time (p. 58)	CAMERA
AUTO TV ON	● OFF	—	VTR CAMERA
	ON	To automatically turn on the Sony TV when using the laser link function	
TV INPUT	● VIDEO1 VIDEO2 VIDEO3	To switch the video input on a Sony TV when using the laser link function (p. 25)	VTR CAMERA
	OFF	—	
LTR SIZE	● NORMAL	To display selected menu items in normal size	VTR
	2x	To display selected menu items at twice the normal size	CAMERA
DEMO MODE	● ON	To make the demonstration appear	CAMERA
	OFF	To cancel the demonstration mode	

Note on AUDIO MODE

When playing back a tape recorded in the 16-bit mode, you cannot adjust the balance in AUDIO MIX.

Notes on DEMO MODE

- You cannot select DEMO MODE when a cassette is inserted in your camcorder.
- DEMO MODE is set to STBY (Standby) at the factory and the demonstration starts about 10 minutes after you have set the POWER switch to CAMERA without a cassette inserted.
- Note that you cannot select STBY of DEMO MODE in the MENU settings.
- When NIGHTSHOT is set to ON, the NIGHTSHOT indicator appears in the viewfinder or on the LCD screen and you cannot select DEMO MODE in the MENU settings.

*To dub a tape to another VCR

You cannot select AUDIO MODE for tapes recorded in the Digital8 system. You, however, can select AUDIO MODE when you dub tapes recorded in the Hi8/standard 8 system to another VCR using the i.LINK cable.

Changing the MENU settings

Icon/item	Mode	Meaning	POWER switch
 WORLD TIME		To set the clock to the local time. Turn the SEL/PUSH EXEC dial to set a time difference. The clock changes by the time difference you set here. If you set the time difference to 0, the clock returns to the originally set time.	CAMERA
BEEP	● MELODY	To output the melody when you start/stop recording or when an unusual condition occurs on your camcorder	VTR CAMERA
	NORMAL	To output the beep instead of the melody	
	OFF	To cancel the melody and beep sound	
COMMANDER	● ON	To activate the Remote Commander supplied with your camcorder	VTR CAMERA
	OFF	To deactivate the Remote Commander to avoid remote control misoperation caused by other VCR's remote control	
DISPLAY	● LCD	To show the display on the LCD screen and viewfinder	VTR CAMERA
	V-OUT/LCD	To show the display on the TV screen, LCD screen and viewfinder	
REC LAMP	● ON	To light up the camera recording lamp at the front of your camcorder	CAMERA
	OFF	To turn the camera recording lamp off so that the subject is not aware of the recording	
INDICATOR	● BL OFF	To turn off the backlight on display window	VTR CAMERA
	BL ON	To turn on the backlight	

In more than 5 minutes after removing the power source

The "COMMANDER" and "HiFi SOUND" items are returned to their factory settings. The other menu items are held in memory even when the battery is removed, as long as the lithium battery is installed.

Note

If you press DISPLAY with "DISPLAY" set to "V-OUT/LCD" in the MENU settings, the picture from a TV or VCR will not appear on the LCD screen even when your camcorder is connected to outputs on the TV or VCR.

Notes on INDICATOR

- When you select "BL ON", battery life is reduced by about 10 percent during recording.
- When you use power sources other than the battery pack, "BL ON" is automatically selected.

Resetting the date and time

The clock is set to East Coast Standard Time at the factory.

The date and time are held in memory by the lithium battery. If you replace the lithium battery with the battery pack or other power source connected, you need not reset the date and time.

You must reset the date and time when the lithium battery becomes dead with no power source installed.

First, set the year, then the month, the day, the hour and then the minute.

- (1) While the camcorder is in the standby mode, press MENU to display the MENU settings.
- (2) Turn the SEL/PUSH EXEC dial to select , then press the dial.
- (3) Turn the SEL/PUSH EXEC dial to select CLOCK SET, then press the dial.
- (4) Turn the SEL/PUSH EXEC dial to adjust the desired year, then press the dial.
- (5) Set the month, day and hour by turning the SEL/PUSH EXEC dial and pressing the dial.
- (6) Set the minute by turning the SEL/PUSH EXEC dial and pressing the dial by the time signal. The clock starts to move.
- (7) Press MENU to make the MENU settings disappear. The time indicator appears.

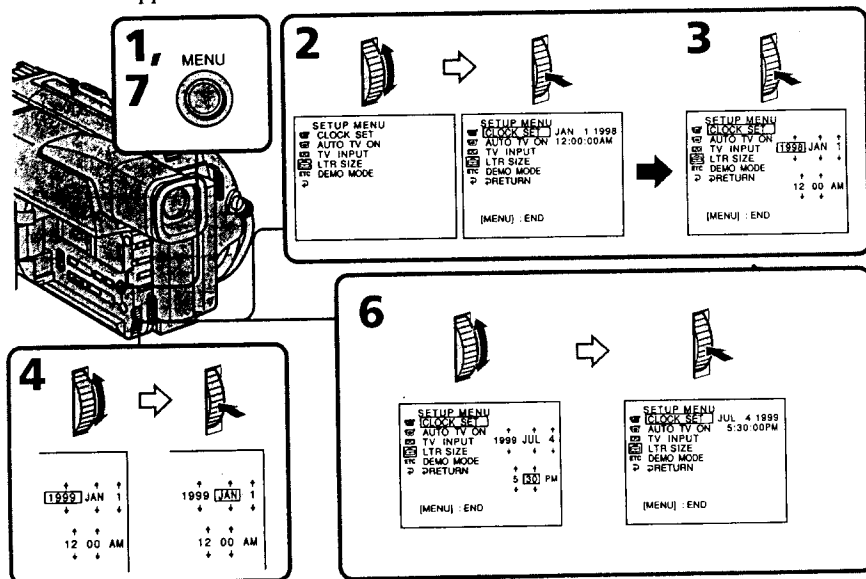

The year changes as follows:

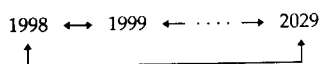

Note on the time indicator

The internal clock of your camcorder operates on a 12-hour cycle.



- 12:00 AM stands for midnight.
- 12:00 PM stands for noon.



Digital8 system, recording and playback

What is the “Digital8 system”?



This video system has been developed to enable digital recording to Hi8 video cassette **Hi8**.

Usable cassette tapes



We recommend using Hi8 video cassette **Hi8**. The recording time when you use your Digital8  system camcorder on Hi8 **Hi8**/standard 8  tape is half the recording time when using the conventional Hi8 **Hi8**/standard 8  system camcorder. (120 minutes of recording time becomes 60 minutes.)



If you use standard 8  tape, be sure to play back the tape on this camcorder. Mosaic pattern noise may appear when you play back standard 8  tape on other VCRs.

Note



Tapes recorded in the Digital8  system cannot be played back on Hi8 **Hi8**/standard 8  (analog) system machine.









Playback system

The Digital8  system or Hi8 **Hi8**/standard 8  system is automatically detected before the tape is played back.*

‡ During playback of tapes recorded in the Hi8 **Hi8**/standard 8  system, digital signals are output as the image signals from the  DV IN/OUT jack.

Display during automatic detection of system

The Digital8  system or Hi8 **Hi8**/standard 8  system is automatically detected, and the playback system is automatically switched to. During switching of systems, the screen turns blue, and the following displays appear. A hissing noise also sometimes can be heard.

 → **Hi8**/: During switching from Digital8  to Hi8 **Hi8**/standard 8 
Hi8/ → : During switching from Hi8 **Hi8**/standard 8  to Digital8 

When you play back

Playing back a PAL-recorded tape

You can play back tapes recorded in the PAL video system on the LCD screen, if the tape is recorded in the Digital8  system.

Copyright signal

When you record

You cannot record software on your camcorder that contains copyright control signals for copyright protection of software.

“COPY INHIBIT” appears on the LCD screen, in the viewfinder or on the TV screen if you try to record such software.

Your camcorder does not record copyright control signals on the tape when it records.

Digital8 [D] system, recording and playback

When you playback a dual sound track tape

When you use tapes recorded in the Digital8 [D] system

When you play back a Digital8 [D] system tape which is dubbed from a dual sound track tape recorded in the DV system, set "HiFi SOUND" to the desired mode in the MENU settings (p. 53).

Sound from speaker

HiFi Sound Mode	Playing back a stereo tape	Playing back a dual sound track tape
STEREO	Stereo	Main sound and sub sound
1	Lch	Main sound
2	Rch	Sub sound

When you use a tape recorded in the Hi8/standard 8 system

When you play back a dual sound track tape recorded in an AFM HiFi stereo system, set "HiFi SOUND" to the desired mode in the MENU settings (p. 53).

Sound from speaker

HiFi Sound Mode	Playing back a stereo tape	Playing back a dual sound track tape
STEREO	Stereo	Main sound and sub sound
1	Monaural	Main sound
2	Unnatural Sound	Sub sound

You cannot record dual sound programs on your camcorder.

Changing the lithium battery in your camcorder

When replacing the lithium battery, keep the battery pack or other power source attached. Otherwise, you will need to reset the date, time and other items in the MENU settings hold in memory by the lithium battery.

Insert the battery with the positive (+) side facing out. When the battery becomes weak or dead, the  indicator flashes in the viewfinder for about 5 seconds when you set the POWER switch to CAMERA. In this case, **replace the battery with a Sony CR2025 or Duracell DL-2025 lithium battery. Use of any other battery may present a risk of fire or explosion.** Discard used batteries according to the manufacturer's instructions.

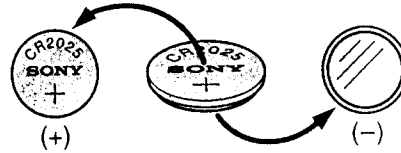

WARNING

The battery may explode if mistreated. Do not recharge, disassemble, nor dispose of it in fire.



Lithium battery

- Keep the lithium battery out of the reach of children.
- Should the battery be swallowed, immediately consult a doctor.
- Wipe the battery with a dry cloth to ensure good contact.

Lithium battery installed at the factory

This battery may not last 1 year.

Changing the lithium battery in your camcorder

Changing the lithium battery

- (1) Open the LCD panel and open the lid of the lithium battery compartment.
- (2) Push the lithium battery down once and pull it out from the holder.
- (3) Install a Sony CR2025 or Duracell DL-2025 lithium battery with the positive (+) side facing out.
- (4) Close the lid.

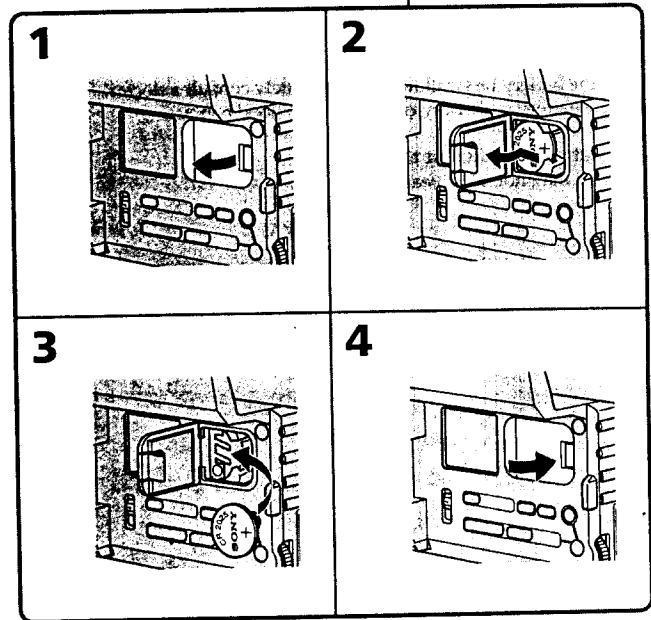
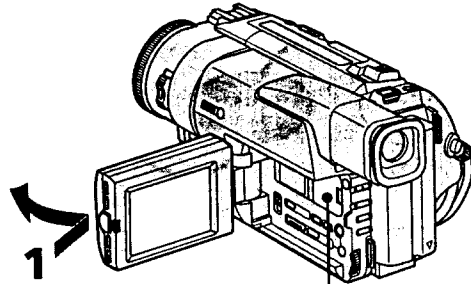

Troubleshooting

If you run into any problem using your camcorder, use the following table to troubleshoot the problem. If the problem persists, disconnect the power source and contact your Sony dealer or local authorized Sony service facility. If "C:□□:□□" appears on the LCD screen or in the viewfinder, the self-diagnosis display function has worked. See page 67.

In the recording mode

Symptom	Cause and/or Corrective Actions
START/STOP does not operate.	<ul style="list-style-type: none"> • The POWER switch is set to VTR. → Set it to CAMERA. (p. 13) • STANDBY is set to LOCK. → Turn STANDBY to STANDBY (p. 13) • The tape has run out. → Rewind the tape or insert a new one. (p. 12, 21) • The write-protect tab is set to expose the red mark. → Use a new tape or slide the tab. (p. 12) • The tape is stuck to the drum (moisture condensation). → Remove the cassette and leave your camcorder for at least 1 hour to acclimatize. (p. 70)
Recording stops in a few seconds.	<ul style="list-style-type: none"> • START/STOP MODE is set to 5SEC or $\frac{1}{2}$. → Set it to $\frac{1}{4}$. (p. 17)
The power goes off.	<ul style="list-style-type: none"> • While being operated in the CAMERA mode, your camcorder has been in the standby mode for more than 3 minutes. → Turn STANDBY down once and then up again. (p. 13)
Your camcorder turns on/off when using the accessory that is attached to the intelligent accessory shoe.	<ul style="list-style-type: none"> • Your camcorder is working with the AC power adaptor. → Use the battery pack.
The image on the viewfinder screen is not clear.	<ul style="list-style-type: none"> • The viewfinder lens is not adjusted. → Adjust the viewfinder lens. (p. 15)
The SteadyShot function does not work.	<ul style="list-style-type: none"> • STEADYSHOT is set to OFF in the MENU settings. → Set it to ON. (p. 53) • The SteadyShot function does not work when the wide mode is set to ON.
The autofocusing function does not work.	<ul style="list-style-type: none"> • FOCUS is set to MANUAL. → Set it to AUTO. (p. 39) • Shooting conditions are not suitable for autofocus. → Set FOCUS to MANUAL to focus manually. (p. 39)
The fader function does not work.	<ul style="list-style-type: none"> • START/STOP MODE is set to 5SEC or $\frac{1}{2}$. → Set it to $\frac{1}{4}$. (p. 17) • The digital effect function is working. → Cancel it. (p. 34)
The \odot indicator flashes in the viewfinder.	<ul style="list-style-type: none"> • The video heads may be dirty. → Clean the heads using the Sony V8-25CLD cleaning cassette (not supplied). (p. 71)
The picture does not appear in the viewfinder.	<ul style="list-style-type: none"> • The LCD panel is open. → Close the LCD panel. (p. 14)

(Continued on the following page)

Troubleshooting



Symptom	Cause and/or Corrective Actions
A vertical band appears when you shoot a subject such as lights or a candle flame against a dark background.	<ul style="list-style-type: none"> The contrast between the subject and background is too high. Your camcorder is not a malfunction.
A vertical band appears when you shoot a very bright subject.	<ul style="list-style-type: none"> Your camcorder is not a malfunction.
Some tiny white spots appear in the viewfinder or on the LCD screen.	<ul style="list-style-type: none"> Slow shutter, low lux or NightShot +Slow shutter mode is activated. This is not a malfunction.
An unknown picture is displayed in the viewfinder or on the LCD screen.	<ul style="list-style-type: none"> If 10 minutes elapse after you set the POWER switch to CAMERA or DEMO MODE is set to ON in the MENU settings without a cassette inserted, your camcorder automatically starts the demonstration. <ul style="list-style-type: none"> → Insert a cassette and the demonstration stops. You can also cancel DEMO MODE. (p. 53)
The picture is recorded in incorrect or unnatural colors.	<ul style="list-style-type: none"> NIGHTSHOT is set to ON. <ul style="list-style-type: none"> → Set it to OFF. (p. 18)
Picture appears too bright, and the subject does not appear in the viewfinder or on the LCD screen.	<ul style="list-style-type: none"> NIGHTSHOT is set to ON in a bright place. <ul style="list-style-type: none"> → Set it to OFF, or use the NightShot function in a dark place. (p. 18)

In the playback mode

Symptom	Cause and/or Corrective Actions
The tape does not move when a video control button is pressed.	<ul style="list-style-type: none"> The POWER switch is set to CAMERA or OFF. <ul style="list-style-type: none"> → Set it to VTR. (p. 21) The tape has run out. <ul style="list-style-type: none"> → Rewind the tape. (p. 21)
The playback picture is not clear or does not appear.	<ul style="list-style-type: none"> The television's video channel is not adjusted correctly. <ul style="list-style-type: none"> → Adjust it. (p. 24)
There are four horizontal lines on the picture or the playback picture is not clear or does not appear.	<ul style="list-style-type: none"> The video head may be dirty. <ul style="list-style-type: none"> → Clean the heads using the Sony V8-25CLD cleaning cassette (not supplied). (p. 71)
No sound or only a low sound is heard when playing back a tape.	<ul style="list-style-type: none"> The stereo tape is played back with HiFi SOUND set to 2 in the MENU settings. <ul style="list-style-type: none"> → Set it to STEREO. (p. 53) The volume is turned to minimum. <ul style="list-style-type: none"> → Open the LCD panel and press VOLUME +. (p. 21) AUDIO MIX is set to ST2 side in the MENU settings. <ul style="list-style-type: none"> → Adjust AUDIO MIX. (p. 53)
The date search does not work correctly.	<ul style="list-style-type: none"> The tape has a blank portion in the recorded portion (p. 45)
The picture which is recorded in the Digital8 8 system is not played back.	<ul style="list-style-type: none"> PB MODE is set to Hi8 / 8 in the MENU settings. <ul style="list-style-type: none"> → Set it to AUTO. (p. 53)
The tape which is recorded in the Hi8 /standard 8 system is not played back correctly.	<ul style="list-style-type: none"> Set PB MODE to Hi8 / 8 in the MENU settings. (p. 53)

Troubleshooting

In the recording and playback modes

Symptom	Cause and/or Corrective Actions
The power does not turn on.	<ul style="list-style-type: none">• The battery pack is not installed, or is dead or nearly dead. → Install a charged battery pack. (p. 8, 9)• The AC power adaptor is not connected to a wall outlet. → Connect the AC power adaptor to a wall outlet. (p. 11)
The end search function does not work.	<ul style="list-style-type: none">• The tape was ejected after recording.• You have not recorded on the new cassette yet.
The battery pack is quickly discharged.	<ul style="list-style-type: none">• The operating temperature is too low.• The battery pack is not fully charged. → Charge the battery pack again. (p. 9)• The battery pack is completely dead, and cannot be recharged. → Replace with a new battery pack. (p. 8)
The battery remaining indicator does not indicate the correct time.	<ul style="list-style-type: none">• You have used the battery pack in an extremely hot or cold environment for a long time.• The battery pack is completely dead, and cannot be recharged. → Replace with a new battery pack. (p. 8)• The battery is dead. → Use a charged battery pack. (p. 8, 9)
The cassette cannot be removed from the holder.	<ul style="list-style-type: none">• The power source is disconnected. → Connect it firmly. (p. 8, 11)• The battery is dead. → Use a charged battery pack or the AC power adaptor. (p. 8, 9)
The  and  indicators flash and no functions except for cassette ejection work.	<ul style="list-style-type: none">• Moisture condensation has occurred. → Remove the cassette and leave your camcorder for at least 1 hour to acclimatize. (p. 70)

(Continued on the following page)

Others

Symptom	Cause and/or Corrective Actions
The Remote Commander supplied with your camcorder does not work.	<ul style="list-style-type: none">• COMMANDER is set to OFF in the MENU settings. → Set it to ON. (p. 53)• Something is blocking the infrared rays. → Remove the obstacle.• The batteries are inserted in the battery holder with the + - polarities incorrectly matching the + - marks. → Insert the batteries with the correct polarity. (p. 80)• The batteries are dead. → Insert new ones. (p. 80)
The picture from a TV or VCR does not appear even when your camcorder is connected to outputs on the TV or VCR.	<ul style="list-style-type: none">• DISPLAY is set to V-OUT/LCD in the MENU settings. → Set it to LCD. (p. 53)
The melody or beep sounds for 5 seconds.	<ul style="list-style-type: none">• Moisture condensation has occurred. → Remove the cassette and leave your camcorder for at least 1 hour to acclimatize. (p. 70)• Some troubles has occurred in your camcorder. → Remove the cassette and insert it again, then operate your camcorder.
While charging the battery pack, no indicator appears or the indicator flashes in the display window.	<ul style="list-style-type: none">• The AC power adaptor is disconnected. → Connect it firmly. (p. 9)• Something is wrong with the battery pack. → Contact your Sony dealer or local authorized Sony service facility.

Self-diagnosis display

Your camcorder has a self-diagnosis display function.

This function displays the current condition of your camcorder as a 5-digit code (a combination of a letter and figures) in the viewfinder, on the LCD screen or in the display window. If a 5-digit code is displayed, check the following code chart. The last two digits (indicated by □□) will differ depending on the state of your camcorder.

Viewfinder (or LCD screen)

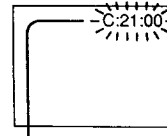

Self-diagnosis display

- C:□□:□□
You can service your camcorder yourself.
- E:□□:□□
Contact your Sony dealer or local authorized Sony facility.

Five-digit display	Cause and/or Corrective Actions
C:04:□□	<ul style="list-style-type: none"> • You are using a battery pack that is not an "InfoLITHIUM" battery pack. → Use an "InfoLITHIUM" battery pack. (p.11)
C:21:□□	<ul style="list-style-type: none"> • Moisture condensation has occurred. → Remove the cassette and leave your camcorder for at least 1 hour to acclimatize. (p. 70)
C:22:□□	<ul style="list-style-type: none"> • The video heads are dirty. → Clean the heads using the Sony V8-25CLD cleaning cassette (not supplied). (p. 71)
C:31:□□	<ul style="list-style-type: none"> • A malfunction other than the above that you can service has occurred. → Remove the cassette and insert it again, then operate your camcorder. → Disconnect the power cord of the AC power adaptor or remove the battery pack. After reconnecting the power source, operate your camcorder.
C:32:□□	
E:61:□□	<ul style="list-style-type: none"> • A malfunction that you cannot service has occurred. → Contact your Sony dealer or local authorized Sony service facility and inform them of the 5-digit code. (example: E:61:10)
E:62:□□	

If you are unable to rectify the problem even if you try corrective actions a few times, contact your Sony dealer or local authorized Sony service facility.

Warning indicators and messages

If indicators and messages appear in the viewfinder, on the LCD screen or in the display window, check the following:

See the page in parentheses "()" for more information.

- The warning messages do not appear in the mirror mode.
- The indicators and messages are displayed in yellow.

Warning indicators

The video heads are dirty

Fast flashing:

- You need to clean the heads using the Sony V8-25CLD cleaning cassette (not supplied) (p. 71).

The battery is dead or nearly dead

Slow flashing:

- The battery is nearly dead.

Fast flashing:

- The battery is dead (p. 9).

Warning indicator as to tape

Slow flashing:

- The tape is near the end.
- No tape is inserted (p. 12).*
- The write-protect tab on the cassette is out (red) (p. 12)*

Fast flashing:

- The tape has run out (p. 12, 21).*

The lithium battery is weak or is not installed

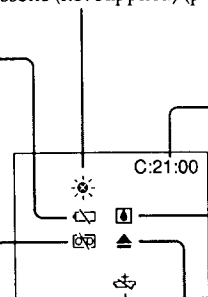

Self-diagnosis display (p. 67)

Moisture condensation has occurred*

Fast flashing:

- Eject the cassette, turn off your camcorder, and leave it for about 1 hour with the cassette compartment open (p. 70).

You need to eject the cassette

Slow flashing:

- The write-protect tab on the cassette is out (red) (p. 12).*

Fast flashing:

- Moisture condensation has occurred (p. 70).
- The tape has run out (p. 12, 21).*
- The self-diagnosis display function is activated (p. 67).

Warning messages



CLEANING CASSETTE The video heads are dirty.



COPY INHIBIT You tried to record a picture that has a copyright control signal (p. 59).

* You hear the melody or beep sound.

Using your camcorder abroad

Using your camcorder abroad

You can use your camcorder in any country or area with the AC power adaptor supplied with your camcorder within 100 V to 240 V AC, 50/60 Hz. When charging the battery pack, use a commercially available AC plug adaptor [a], if necessary, depending on the design of the wall outlet [b].

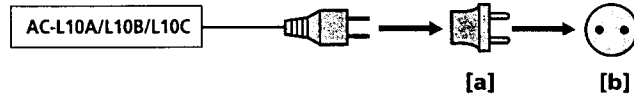

Your camcorder is an NTSC system based camcorder. If you want to view the playback picture on a TV, it must be an NTSC system based TV with VIDEO/AUDIO input jack. The following shows TV color systems used overseas.

NTSC system

Bahama Islands, Bolivia, Canada, Central America, Chile, Colombia, Ecuador, Jamaica, Japan, Korea, Mexico, Peru, Surinam, Taiwan, the Philippines, the U.S.A., Venezuela, etc.

PAL system

Australia, Austria, Belgium, China, Czech Republic, Denmark, Finland, Germany, Great Britain, Holland, Hong Kong, Italy, Kuwait, Malaysia, New Zealand, Norway, Portugal, Singapore, Slovak Republic, Spain, Sweden, Switzerland, Thailand, etc.

PAL-M system

Brazil

PAL-N system

Argentina, Paraguay, Uruguay

SECAM system



Bulgaria, France, Guyana, Hungary, Iran, Iraq, Monaco, Poland, Russia, Ukraine, etc.

Simple setting of clock by time difference

You can easily set the clock to the local time by setting a time difference. Select WORLD TIME in the MENU settings. See page 53 for more information.

Maintenance information and precautions

Moisture condensation

If your camcorder is brought directly from a cold place to a warm place, moisture may condense inside your camcorder, on the surface of the tape, or on the lens. In this condition, the tape may stick to the head drum and be damaged or your camcorder may not operate correctly. If there is moisture inside your camcorder, the beep sounds and the  indicator flashes. When the  indicator flashes at the same time, the cassette is inserted in your camcorder. If moisture condenses on the lens, the indicator will not appear.

If moisture condensation occurred

None of the functions except cassette ejection will work. Eject the cassette, turn off your camcorder, and leave it for about 1 hour with the cassette compartment open. Your camcorder can be used again if the  indicator does not appear when the power is turned on again.

Note on moisture condensation

Moisture may condense when you bring your camcorder from a cold place into a warm place (or vice versa) or when you use your camcorder in a hot place as follows:

- You bring your camcorder from a ski slope into a place warmed up by a heating device
- You bring your camcorder from an air-conditioned car or room into a hot place outside
- You use your camcorder after a squall or a shower
- You use your camcorder in a high temperature and humidity place

How to prevent moisture condensation



When you bring your camcorder from a cold place into a warm place, put your camcorder in a plastic bag and tightly seal it. Remove the bag when the air temperature inside the plastic bag has reached the surrounding temperature (after about 1 hour).

Maintenance information and precautions

Maintenance information

Cleaning the video head

To ensure normal recording and clear pictures, clean the video heads. The video head may be dirty when:

- mosaic-pattern noise appears on the playback picture.
- playback pictures do not move.
- playback pictures are hardly visible.
- playback pictures do not appear.
- the  indicator and "  CLEANING CASSETTE" message appear one after another or the  indicator flashes on the LCD screen or in the viewfinder.

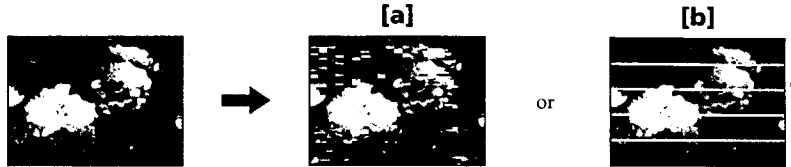



If the above problem, [a] or [b] occurs, clean the video heads with the Sony V8-25CLD cleaning cassette (not supplied). Check the picture and if the above problem persists, repeat cleaning.

Cleaning the LCD screen

If fingerprints or dust make the LCD screen dirty, we recommend using a LCD Cleaning Kit (not supplied) to clean the LCD screen.

Removing dust from inside the viewfinder

- (1)  Remove the screw with a screwdriver (not supplied).  Then, while sliding the RELEASE knob,  turn the eyecup in the direction of the arrow and pull it out.
- (2) Clean the surface with a commercially available blower for a still camera.
- (3) Reattach the eyecup and replace the screw.

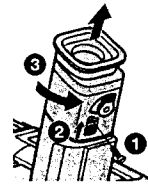

Caution

Do not remove any other screws. You may remove only the screw to remove the eyecup.

Maintenance information and precautions

Precautions

Camcorder operation

- Operate your camcorder on 7.2 V (battery pack) or 8.4 V (AC power adaptor).
- For DC or AC operation, use the accessories recommended in this operating instructions.
- If any solid object or liquid get inside the casing, unplug your camcorder and have it checked by a Sony dealer before operating it any further.
- Avoid rough handling or mechanical shock. Be particularly careful of the lens.
- Keep the POWER switch set to OFF when you are not using your camcorder.
- Do not wrap your camcorder with a towel, for example, and operate it. Doing so might cause heat to build up inside.
- Keep your camcorder away from strong magnetic fields or mechanical vibration.
- Do not touch the LCD screen with your fingers or a sharp-pointed object.
- If your camcorder is used in a cold place, a residual image may appear on the LCD screen. This is not a malfunction.
- While using your camcorder, the back of the LCD screen may heat up. This is not a malfunction.

On handling tapes

Do not insert anything into the small holes on the rear of the cassette. These holes are used to sense the type and thickness of the tape and if the recording tab is in or out.

Camcorder care

- Remove the tape, and periodically turn on the power, operate the CAMERA and VTR sections and play back a tape for about 3 minutes when your camcorder is not to be used for a long time.
- Clean the lens with a soft brush to remove dust. If there are fingerprints on the lens, remove them with a soft cloth.
- Clean the camcorder body with a dry soft cloth, or a soft cloth lightly moistened with a mild detergent solution. Do not use any type of solvent which may damage the finish.
- Do not let sand get into your camcorder. When you use your camcorder on a sandy beach or in a dusty place, protect it from the sand or dust. Sand or dust may cause your camcorder to malfunction, and sometimes this malfunction cannot be repaired.

Maintenance information and precautions

AC power adaptor

- Unplug the unit from the wall outlet when you are not using the unit for a long time. To disconnect the power cord, pull it out by the plug. Never pull the power cord itself.
- Do not operate the unit with a damaged cord or if the unit has been dropped or damaged.
- Do not bend the power cord forcibly, or place a heavy object on it. This will damage the cord and may cause fire or electrical shock.
- Prevent metallic objects from coming into contact with the metal parts of the connecting section. If this happens, a short may occur and the unit may be damaged.
- Always keep metal contacts clean.
- Do not disassemble the unit.
- Do not apply mechanical shock or drop the unit.
- While the unit is in use, particularly during charging, keep it away from AM receivers and video equipment. AM receivers and video equipment disturb AM reception and video operation.
- The unit becomes warm during use. This is not a malfunction.
- Do not place the unit in locations that are:
 - Extremely hot or cold
 - Dusty or dirty
 - Very humid
 - Vibrating

Notes on dry batteries

- To avoid possible damage from battery leakage or corrosion, observe the following:
 - Be sure to insert the batteries with the + - polarities matched to the + - marks.
 - Dry batteries are not rechargeable.
 - Do not use a combination of new and old batteries.
 - Do not use different types of batteries.
 - Current flows from batteries when you are not using them for a long time.
 - Do not use leaking batteries.

If batteries are leaking

- Wipe off the liquid in the battery compartment carefully before replacing the batteries.
- If you touch the liquid, wash it off with water.
- If the liquid get into your eyes, wash your eyes with a lot of water and then consult a doctor.

If any problem occurs, unplug your camcorder and contact your nearest Sony dealer.

Specifications

Video camera recorder

System

Video recording system

2 rotary heads
Helical scanning system

Audio recording system

Rotary heads, PCM system
Quantization: 12 bits (Fs 32 kHz, stereo 1, stereo 2), 16 bits (Fs 48 kHz, stereo)

Video signal

NTSC color, EIA standards

Recommended cassette

Hi8 video cassette

Recording/playback time (using 120 min. cassette)

1 hours

Fastforward/rewind time (using 120 min. cassette)

Approx. 8 min.

Image device

1/4 inch CCD (Charge Coupled Device)

Approx. 460,000 pixels

(Effective: Approx. 290,000 pixels)

Lens

Combined power zoom lens

Filter diameter 1 7/16 in. (37 mm)

20x (Optical), 360x (Digital)

Focal length

5/32 - 2 7/8 in. (3.6 - 72 mm)

When converted to a 35 mm still camera

1 5/8 - 32 3/8 in. (41 - 820 mm)

Color temperature

Auto

Minimum illumination

1 lux (F 1.4)

0 lux (in the NightShot mode)*

* Objects unable to be seen due to the dark can be shot with infrared lighting.

Input and output connector

5 video input/output

4-pin mini DIN

Luminance signal: 1 Vp-p,

75 ohms, unbalanced

Chrominance signal: 0.286 Vp-p,

75 ohms, unbalanced

Video input/output

Phono jack, 1 Vp-p, 75 ohms,

unbalanced

Audio input/output

Phono jacks (2: stereo L and R)

327 mV, (at output impedance

47 kilohms) impedance less than

2.2 kilohms

RFU DC OUT

Special minilack, DC 5V

DV input/output

4-pin connector

Headphone jack

Stereo minijack (ø 3.5 mm)

LANC control jack

Stereo mini-minijack (ø 2.5 mm)

MIC jack

Minijack, 0.388 mV low impedance

with 2.5 to 3.0 V DC, output

impedance 6.8 kilohms (ø 3.5 mm)

Stereo type

LCD screen

Picture

2.5 inches measured diagonally

2 x 1 1/2 in. (50.3 x 37.4 mm)

Total dot number

61,380 (279 x 220)

General

Power requirements

7.2 V (battery pack)

8.4 V (AC power adaptor)

Average power consumption (when using the battery pack)

During camera recording using

LCD

3.5 W

Viewfinder

3.1 W

Operating temperature

32 °F to 104 °F (0 °C to 40 °C)

Storage temperature

-4 °F to +140 °F (-20 °C to +60 °C)

Dimensions (Approx.)

4 x 4 1/4 x 8 5/8 in.

(101 x 107 x 217 mm) (w/h/d)

Mass (approx.)

1 lb 15 oz (890 g)

excluding the battery pack, lithium

battery, cassette and shoulder

strap

2 lb 3 oz (1 kg)

including the battery pack

NP-F330, lithium battery CR2025,

120 min. cassette and shoulder

strap

Supplied accessories

See page 7.

AC power adaptor

Power requirements

100 - 240 V AC, 50/60 Hz

Power consumption

23 W

Output voltage

DC OUT: 8.4 V, 1.5 A in operating

mode

Operating temperature

32 °F to 104 °F (0 °C to 40 °C)

Storage temperature

-4 °F to +140 °F (-20 °C to +60 °C)

Dimensions (approx.)

5 x 1 9/16 x 2 1/2 in.

(125 x 39 x 62 mm) (w/h/d)

excluding projecting parts

Mass (approx.)

9.8 oz (280 g)

excluding power cord

Cord length (approx.)

AC power cord: 6.6 feet (2 m)

Connecting cord: 5.2 feet (1.6 m)

Design and specifications are subject to change without notice.

Identifying the parts and controls

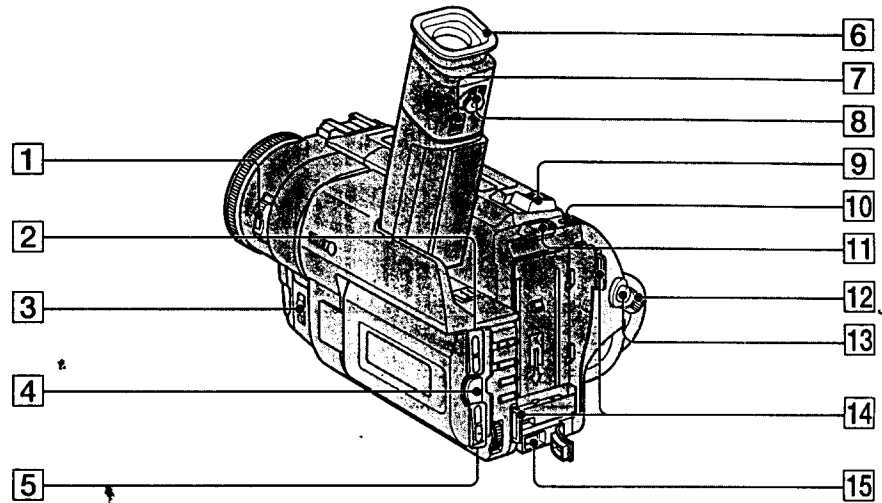

- | | |
|---------------------------------------------------|-------------------------------------------|
| 1 POWER switch (p. 13) | 9 Power zoom lever (p. 16) |
| 2 LCD BRIGHT buttons (p. 14) | 10 PHOTO button (p. 26) |
| 3 FOCUS switch (p. 39) | 11 BATT RELEASE lever (p. 8) |
| 4 OPEN button (p. 13) | 12 STANDBY switch (p. 13) |
| 5 VOLUME buttons (p. 21) | 13 START/STOP button (p. 13) |
| 6 Eyecup (p. 71) | 14 Hook for shoulder strap (p. 77) |
| 7 Eyecup RELEASE knob (p. 71) | 15 DC IN jack (p. 9) |
| 8 Viewfinder lens adjustment lever (p. 15) | |



This mark indicates that this product is a genuine accessory for Sony video products. When purchasing Sony video products, Sony recommends that you purchase accessories with this "GENUINE VIDEO ACCESSORIES" mark.

Identifying the parts and controls

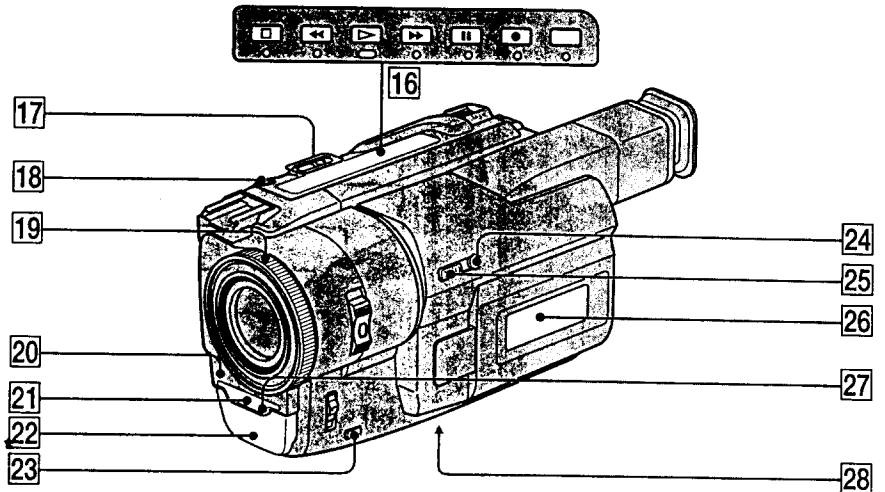

16 Video control buttons (p. 21, 23, 43, 50, 58)

- STOP (stop)
- ◀◀ REW (rewind)
- ▶▶ PLAY (playback)
- ▶▶ FF (fastforward)
- || PAUSE (pause)
- REC (recording)

The control buttons light up when you set the POWER switch to VTR.

17 EDITSEARCH buttons (p. 20)

18 LASER LINK button (p. 25)

19 Focus ring (p. 39)

20 Camera recording lamp (p. 13)

21 Infrared rays emitter (p. 18, 25)

22 Microphone

23 PUSH AUTO button (p. 39)

24 +SLOW SHUTTER button (p. 19)

25 NIGHTSHOT switch (p. 18)

26 Display window (p. 81)

27 Remote sensor (p. 80)

28 Tripod receptacle (base)

Make sure that the length of the tripod screw is less than 9/32 inch (6.5 mm). Otherwise, you cannot attach the tripod securely and the screw may damage your camcorder.

What is LASER LINK?

The LASER LINK system sends and receives pictures and sound between video equipment having the  mark by using infrared rays.

Identifying the parts and controls

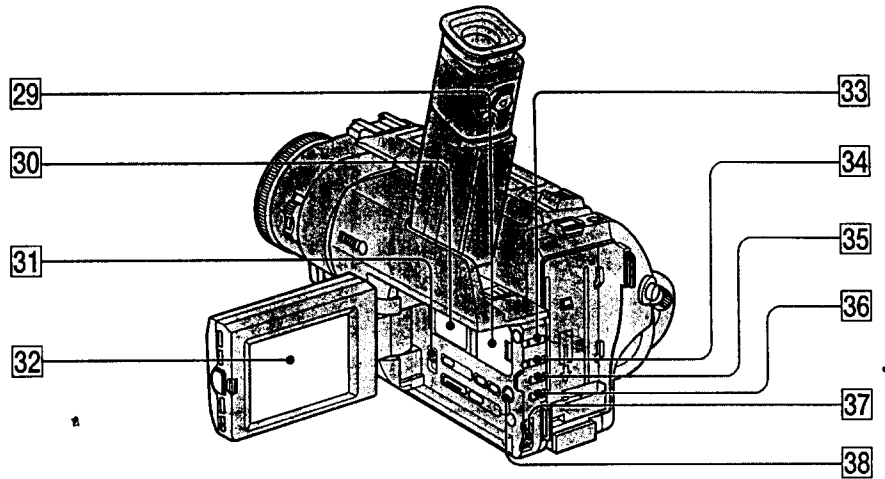

- | | |
|-----------------------------------------------|--------------------------------------|
| 29 Lithium battery compartment (p. 62) | 35 PROGRAM AE button (p. 37) |
| 30 Speaker | 36 EXPOSURE button (p. 38) |
| 31 START/STOP MODE switch (p. 17) | 37 SEL/PUSH EXEC dial (p. 32) |
| 32 LCD screen (p. 14) | 38 MENU button (p. 28, 53) |
| 33 FADER button (p. 30) | |
| 34 BACK LIGHT button (p. 18) | |

Quick Reference

Attaching the shoulder strap

Attach the shoulder strap supplied with your camcorder to the hooks for the shoulder strap.



Identifying the parts and controls

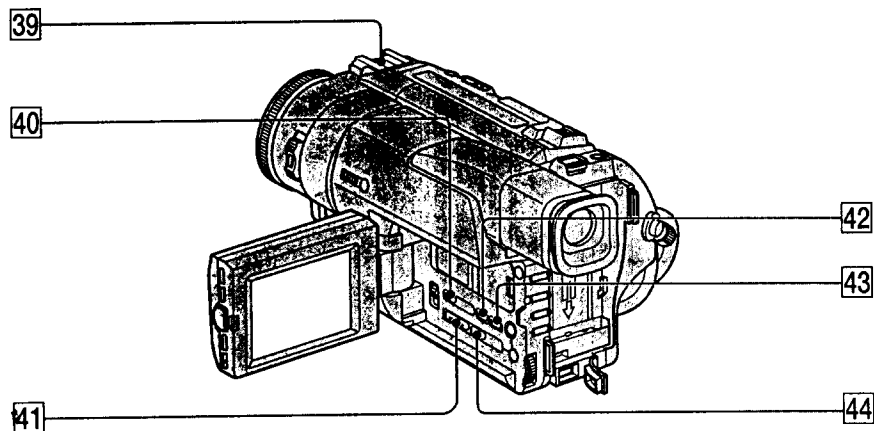

39 Intelligent accessory shoe

40 DATA CODE button (p. 22)

41 DIGITAL EFFECT button (p. 34, 42)

42 DISPLAY button (p. 22)

43 END SEARCH button (p. 20)

44 PICTURE EFFECT button (p. 32, 41)





Intelligent Accessory Shoe

Notes on the intelligent accessory shoe

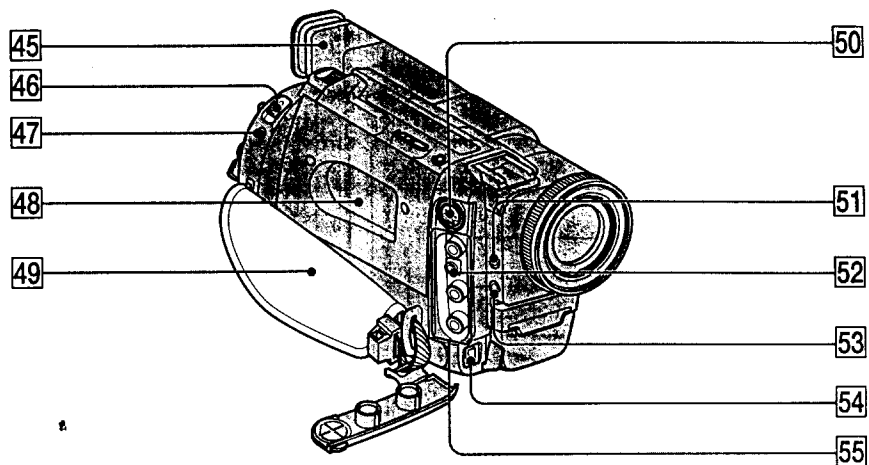
- The intelligent accessory shoe supplies power to optional accessories such as a video light or microphone.
- The intelligent accessory shoe is linked to STANDBY, allowing you to turn the power supplied by the shoe on and off. Refer to the operating instructions of the accessory for further information.
- The intelligent accessory shoe has a safety device for fixing the installed accessory securely. To connect an accessory, press down and push it to the end, and then tighten the screw.
- To remove an accessory, loosen the screw, and then press down and pull out the accessory.

Identifying the parts and controls



- 45** Viewfinder (p. 15)
- 46** EJECT switch (p. 12)
- 47** LANC  control jack
LANC stands for Local Application Control Bus System. The  control jack is used for controlling the tape transport of video equipment and other peripherals connected to the video equipment. This jack has the same function as the jack indicated as CONTROL L or REMOTE.
- 48** Cassette compartment (p. 12)
- 49** Grip strap
- 50** S VIDEO jack (p. 24, 27, 48, 50)
- 51**  (headphones) jack
When you use headphones, the speaker on your camcorder is silent.
- 52** RFU DC OUT (RFU adaptor DC output) jack (p. 24)
- 53** MIC jack (PLUG IN POWER)
Connect an external microphone (not supplied). This jack also accepts a "plug-in-power" microphone. If you connect a 2-pin microphone, supply power from DC OUT jack.
- 54**  DV IN/OUT jack (p. 49)
This "i.LINK" mark is a trademark of Sony Corporation and indicates that this product is in agreement with IEEE 1394-1995 specifications and their revisions.

The  DV IN/OUT jack is i.LINK compatible.
- 55** VIDEO/AUDIO jacks (p. 24, 27, 48, 50)

Fastening the grip strap

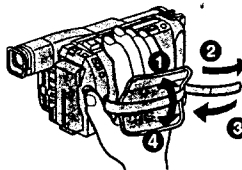

Fasten the grip strap firmly.

Identifying the parts and controls

Remote Commander

The buttons that have the same name on the Remote Commander as on your camcorder function identically to the buttons on your camcorder.

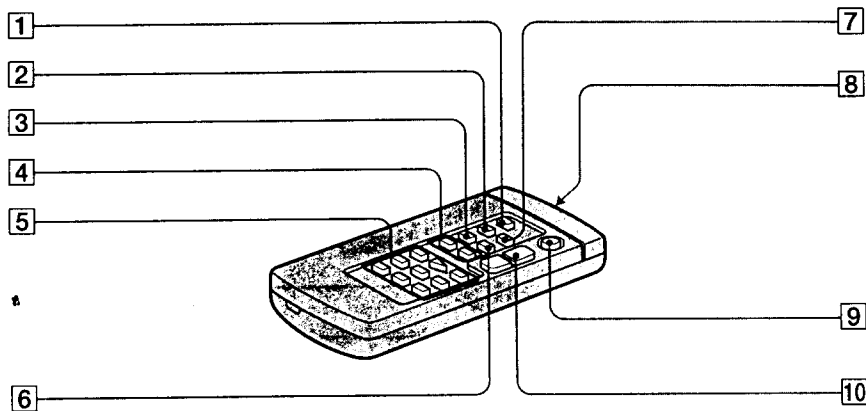

- 1 PHOTO button (p. 26)
- 2 DISPLAY button (p. 22)
- 3 SEARCH MODE button (p. 44, 46, 47)
- 4 ◀▶/▶▶ buttons (p. 44, 46, 47)
- 5 Tape transport buttons (p. 21)
- 6 DATA CODE button (p. 22)

- 7 ZERO SET MEMORY button (p. 40, 43, 52)
- 8 Transmitter
Point toward the remote sensor to control the camcorder after turning on the camcorder.
- 9 START/STOP button (p. 13)*
- 10 Power zoom button (p. 16)

To prepare the Remote Commander

Insert 2 size AA (R6) batteries by matching the + and - polarities on the batteries to the + - marks inside the battery compartment.

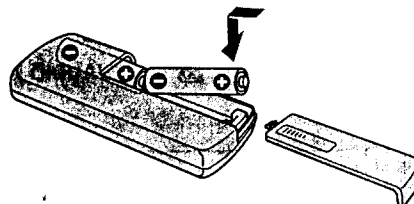

Notes on the Remote Commander

- Point the remote sensor away from strong light sources such as direct sunlight or overhead lighting. Otherwise, the Remote Commander may not function properly.
- Your camcorder works in the commander mode VTR 2. Commander modes 1, 2 and 3 are used to distinguish your camcorder from other Sony VCRs to avoid remote control misoperation. If you use another Sony VCR in the Commander mode VTR 2, we recommend changing the commander mode or covering the sensor of the VCR with black paper.

Operation Indicators

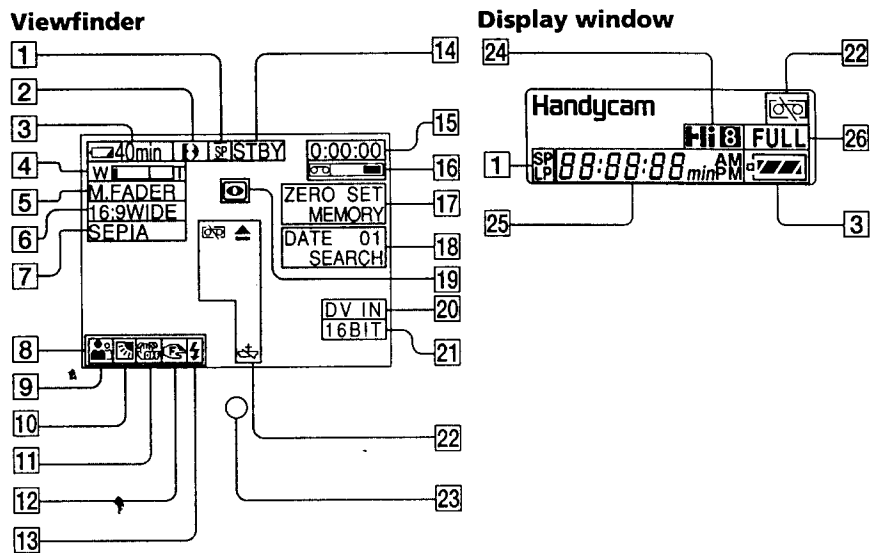

- 1** **Tape speed mode indicator**
This indicator appears while playing back in the Hi8/standard 8 system.
/Mirror mode indicator (p. 14)
- 2** **Format indicator** (p. 59)
f, **Hi8** or **8** indicator appears.
- 3** **Remaining battery time indicator** (p. 17)
- 4** **Exposure indicator** (p. 38)/**Zoom indicator** (p. 16)
- 5** **Fader indicator** (p. 30)/**Digital effect indicator** (p. 34, 42)
- 6** **Wide mode indicator** (p. 28)
- 7** **Picture effect indicator** (p. 32, 41)
- 8** **LCD bright indicator** (p. 14)/**Volume indicator** (p. 21)/**Data code indicator** (p. 22)
- 9** **PROGRAM AE indicator** (p. 37)
- 10** **Backlight indicator** (p. 18)
- 11** **SteadyShot off indicator** (p. 54)
- 12** **Manual focusing indicator** (p. 39)
- 13** **Video flash ready indicator**
This indicator appears when you use the video flash light (not supplied).
- 14** **Standby/Recording indicator** (p. 13)/**Video control mode** (p. 23)
- 15** **Tape counter** (p. 40, 43, 52)/**Time code indicator** (p. 17)/**Self-diagnosis display function indicator** (p. 67)/**5SEC mode indicator** (p. 17)/**Photo recording indicator** (p. 26)
- 16** **Remaining tape indicator** (p. 17)
- 17** **ZERO SET MEMORY indicator** (p. 40, 43, 52)
- 18** **Search mode indicator** (p. 20, 44, 46, 47)
- 19** **NIGHTSHOT indicator** (p. 18, 19)
- 20** **DV IN indicator** (p. 49)
- 21** **Audio mode indicator** (p. 56)
- 22** **Warning indicators** (p. 68)
- 23** **Recording lamp** (p. 13)
- 24** **Hi8 indicator**
This indicator appears while playing back in the Hi8 system.
- 25** **Tape counter** (p. 40, 43, 52)/**Time code indicator** (p. 17)/**Self-diagnosis display function indicator** (p. 67)/**Remaining battery time indicator** (p. 9)
- 26** **FULL charge indicator** (p. 9)

Quick Reference

Quick Function Guide

Functions to adjust exposure (in the recording mode)

- In a dark place NIGHTSHOT (p. 18)
- In insufficient light Low lux mode (p. 36)
- In dark environments such as sunset, fireworks, or general night views Sunset & moon mode (p. 36)
- Shooting backlit subjects BACK LIGHT (p. 18)
- In spotlight, such as at the theater or a formal event Spotlight mode (p. 36)
- In strong light or reflected light, such as at a beach in midsummer or on a ski slope Beach & ski mode (p. 36)

Functions to give images more impact (in the recording mode)

- Smooth transition between scenes FADER (p. 30)
- Taking a still picture PHOTO (p. 26)
- Digital processing of images PICTURE EFFECT (p. 32)
- Processing a scene using digital effects DIGITAL EFFECT (p. 34)
- Creating a soft background for subjects Soft portrait mode (p. 36)

Functions to give a natural appearance to your recordings (in the recording mode)

- Preventing deterioration of picture quality in digital zoom D ZOOM [MENU] (p. 53)
- Focusing manually Manual focus (p. 39)
- Shooting distant subjects Landscape mode (p. 36)
- Recording fast-moving subjects Sports lesson mode (p. 36)

Functions to use in editing (in the recording mode)

- Watching the picture on a wide-screen TV Wide mode (p. 28)

Functions to use after recording (in the playback mode)

- Digital processing of recorded images PICTURE EFFECT (p. 41)
- Processing a recorded scene using digital effects DIGITAL EFFECT (p. 42)
- Displaying the date/time or recording data when you recorded Data code (p. 22)
- Quickly locating a desired scene Zero set memory (p. 40, 43, 52)
- Searching for scenes recorded in the photo mode Photo search (p. 46)
- Scanning scenes recorded in the photo mode Photo scan (p. 47)
- Playing back on monaural sound or sub sound HiFi SOUND [MENU] (p. 53)
- Playing back the picture on a TV without connecting a cord LASER LINK (p. 25)

Sony Corporation Printed in Japan

Sony  line <http://www.world.sony.com/>

Printed on recycled paper